

playmobil®

6195

Wichtige Unterlagen, bitte sorgfältig aufbewahren !
Important: Please keep these instructions for future reference !
Documents importants, à conserver soigneusement !
Belangrijke documenten, bewaar deze zorgvuldig !



WARNING: CHOKING HAZARD

Contains a small ball and small parts.
Not for children under 3 years.

"Ne concerne que les USA"

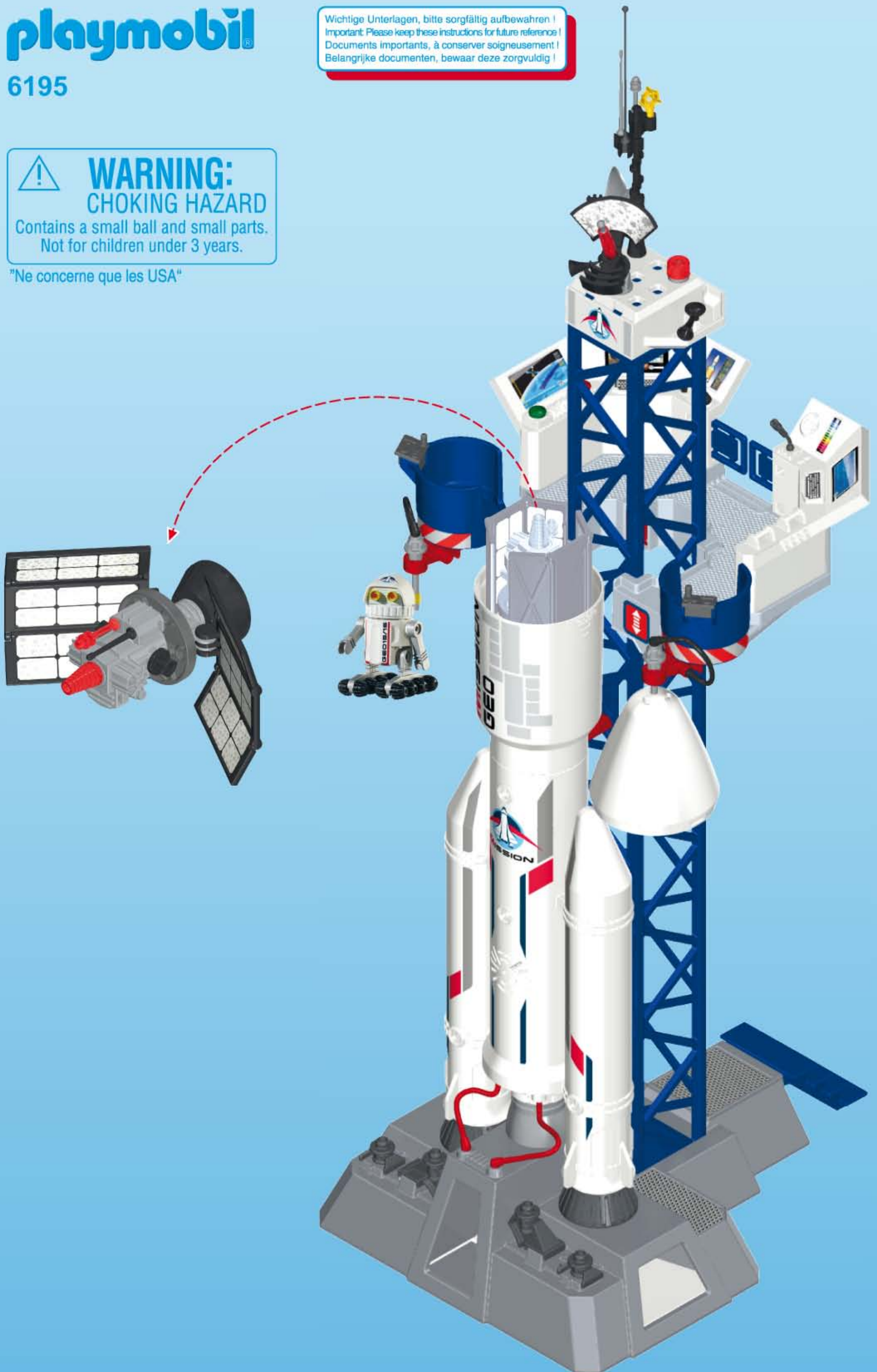

1

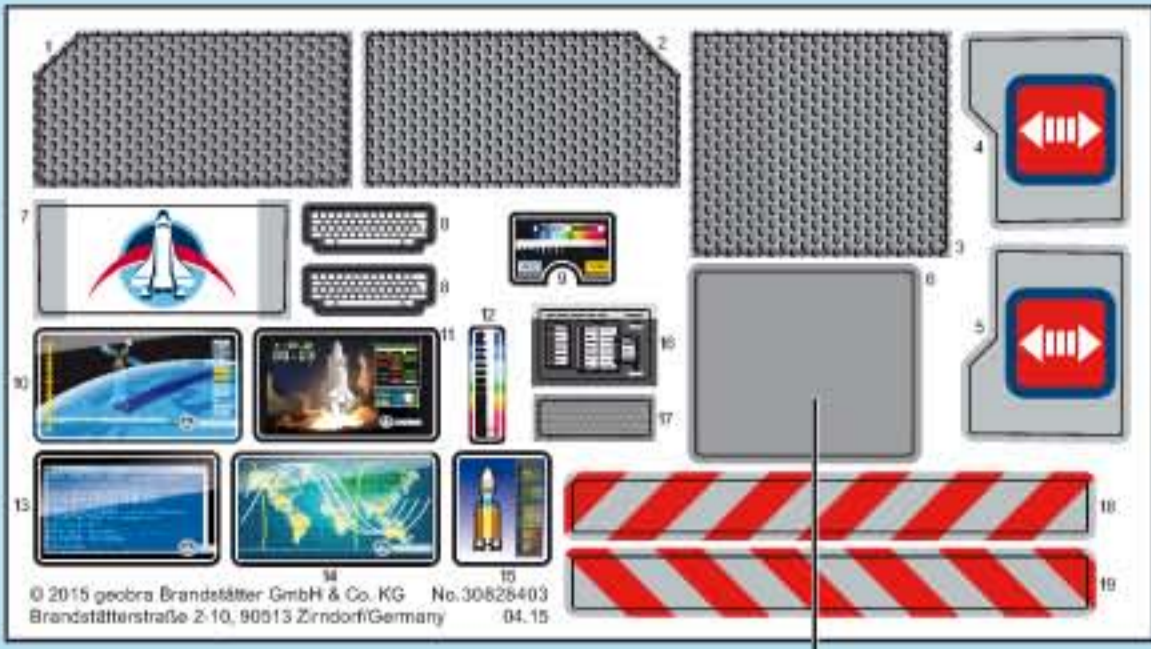

6

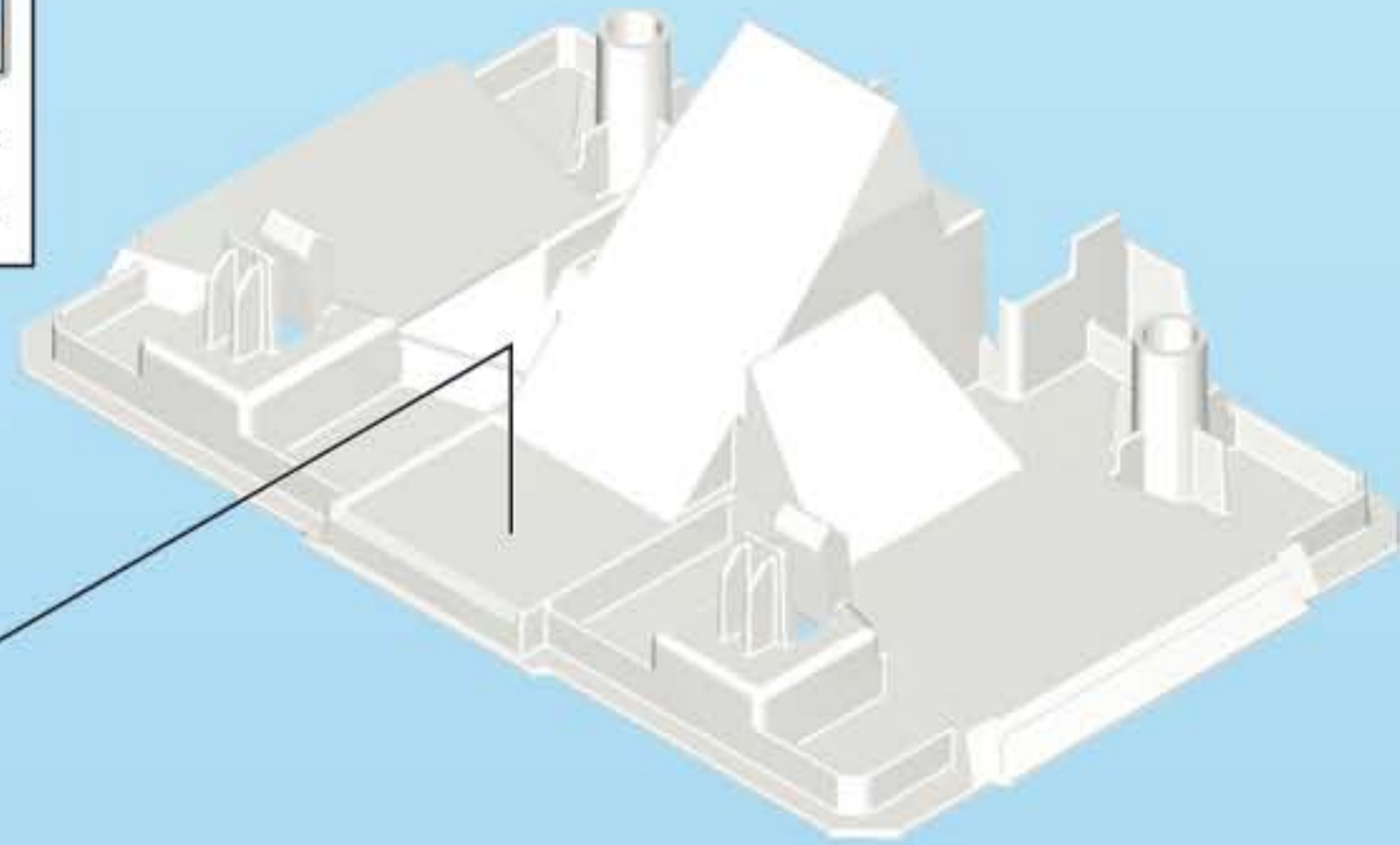

2

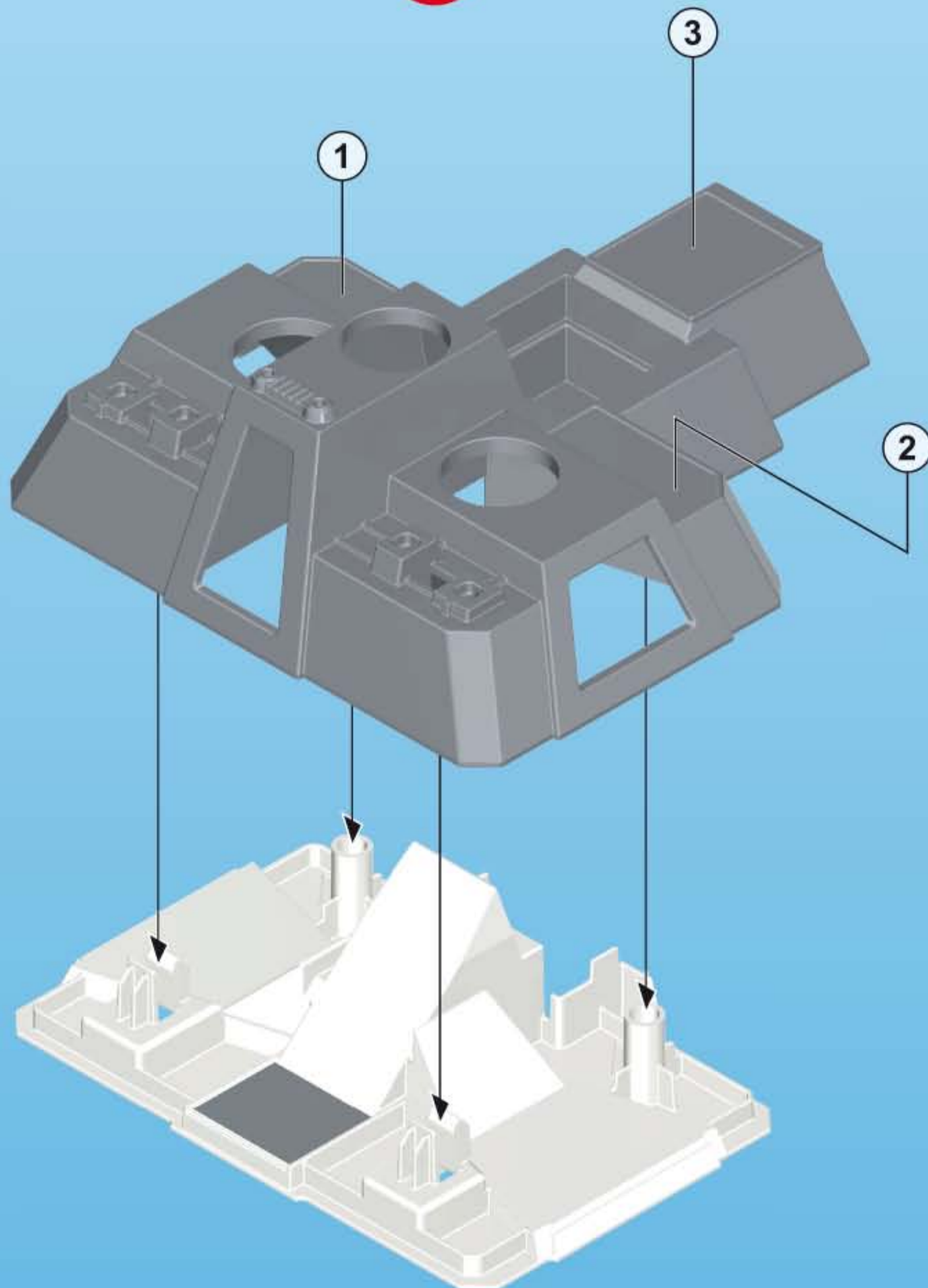

3

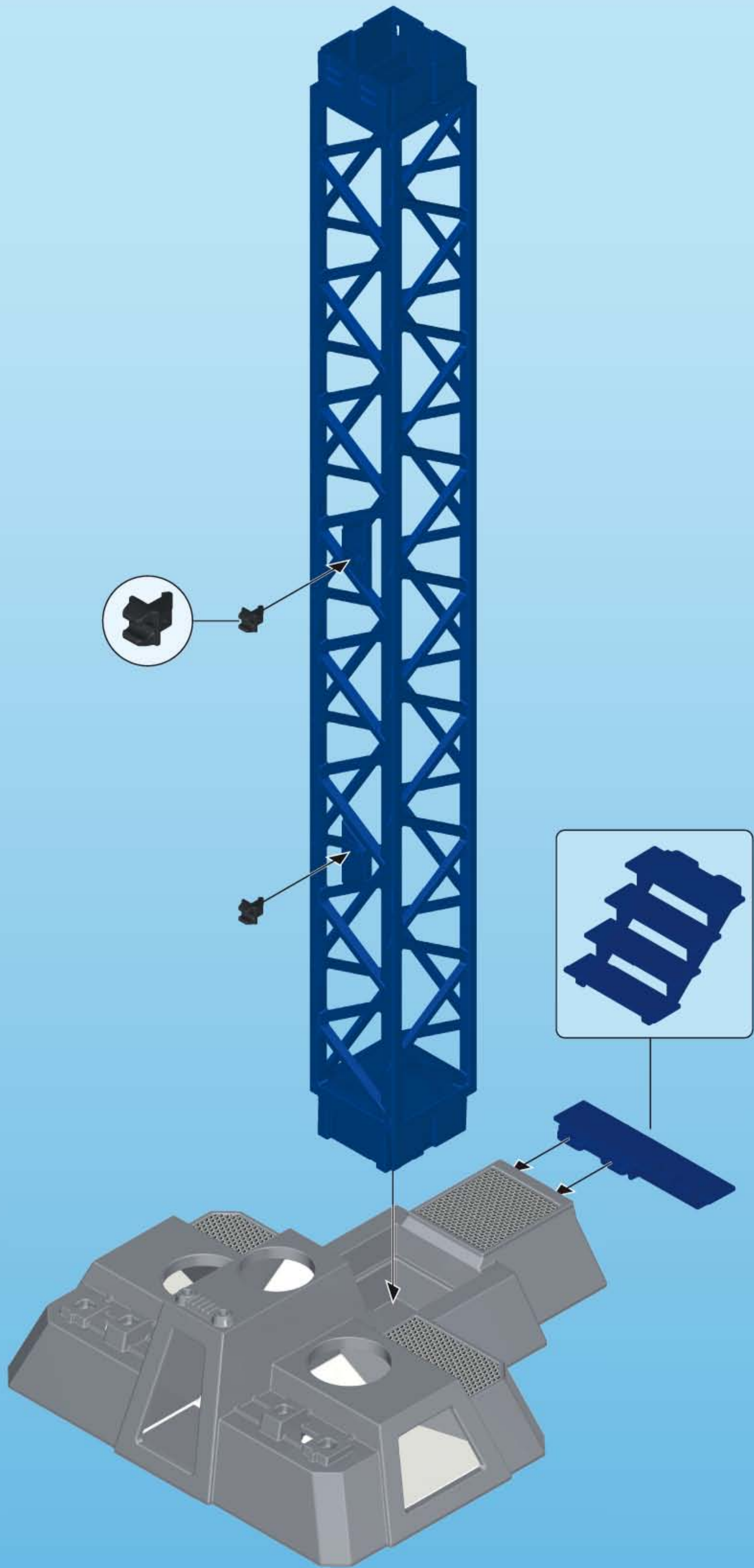

1

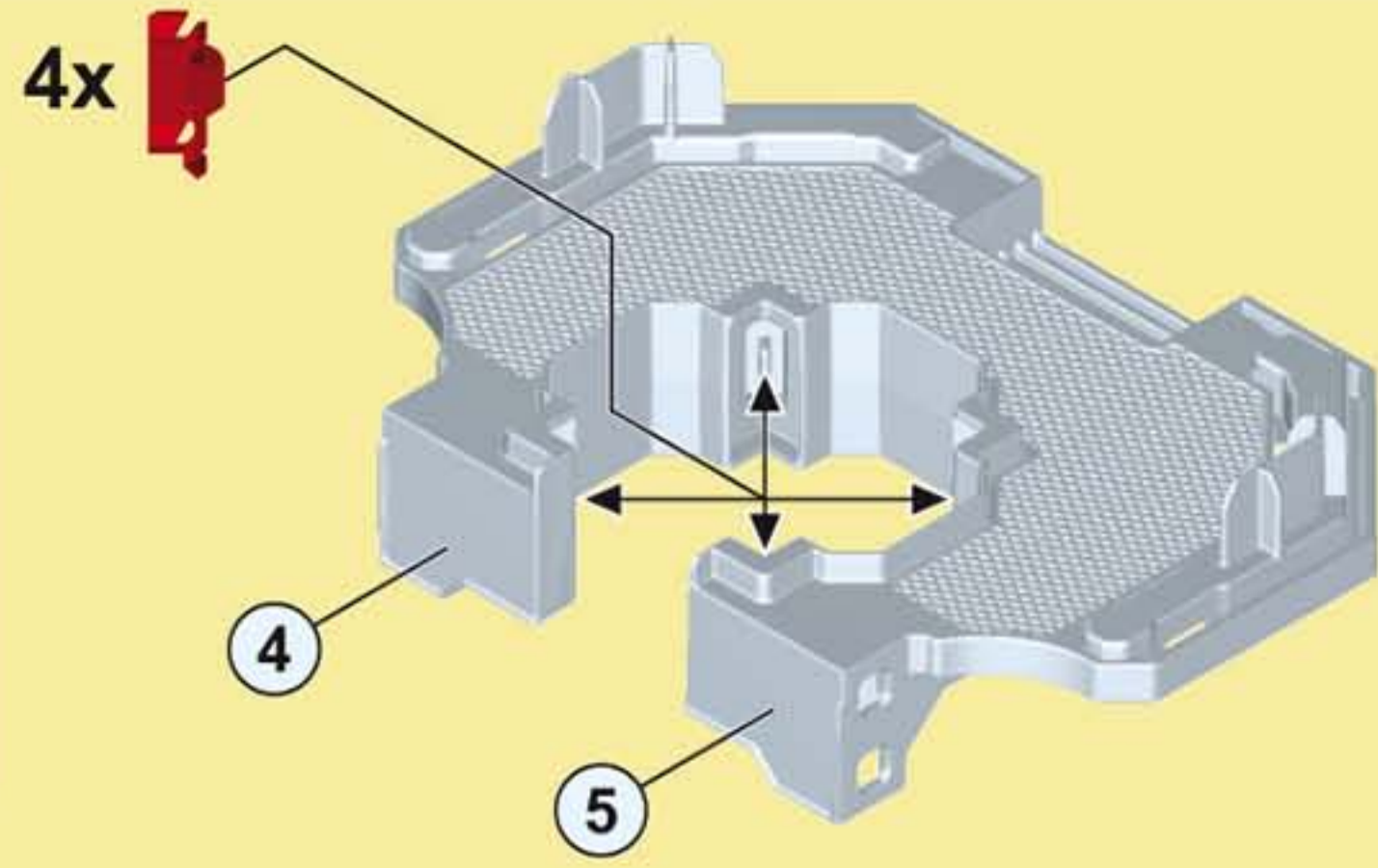
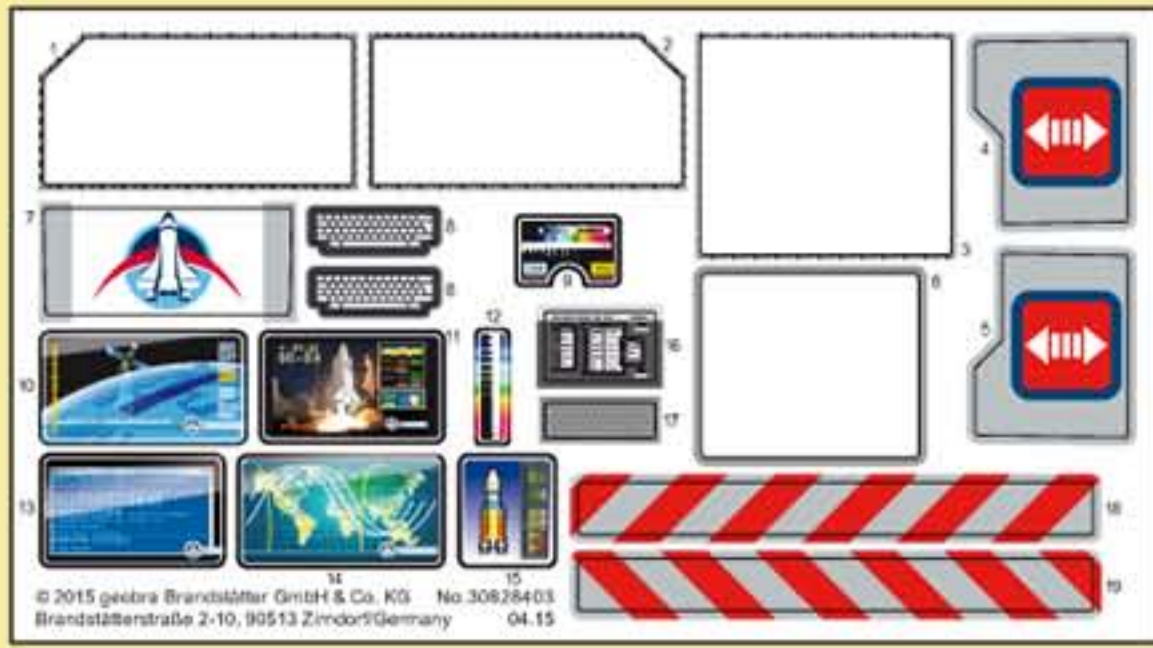

2

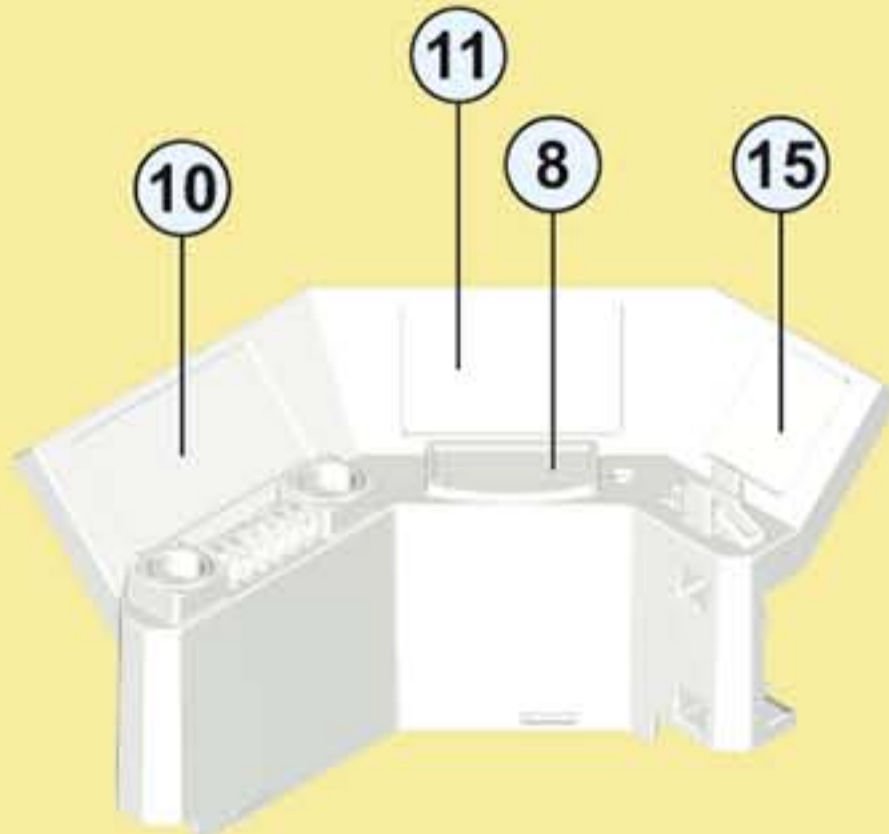

3



4

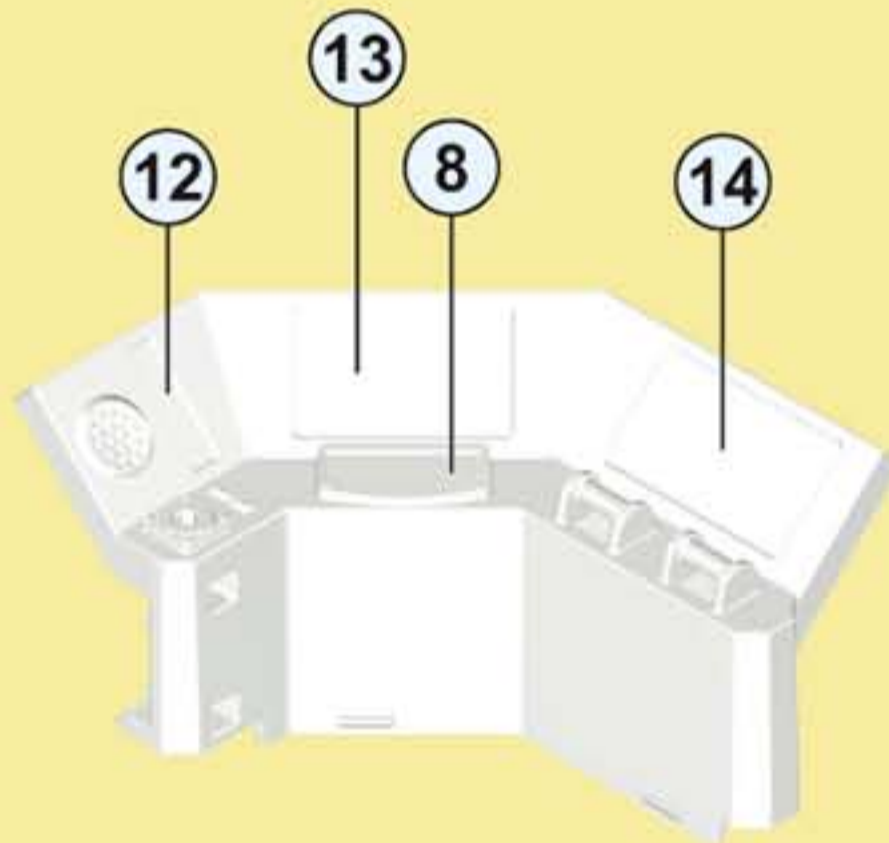

5



6

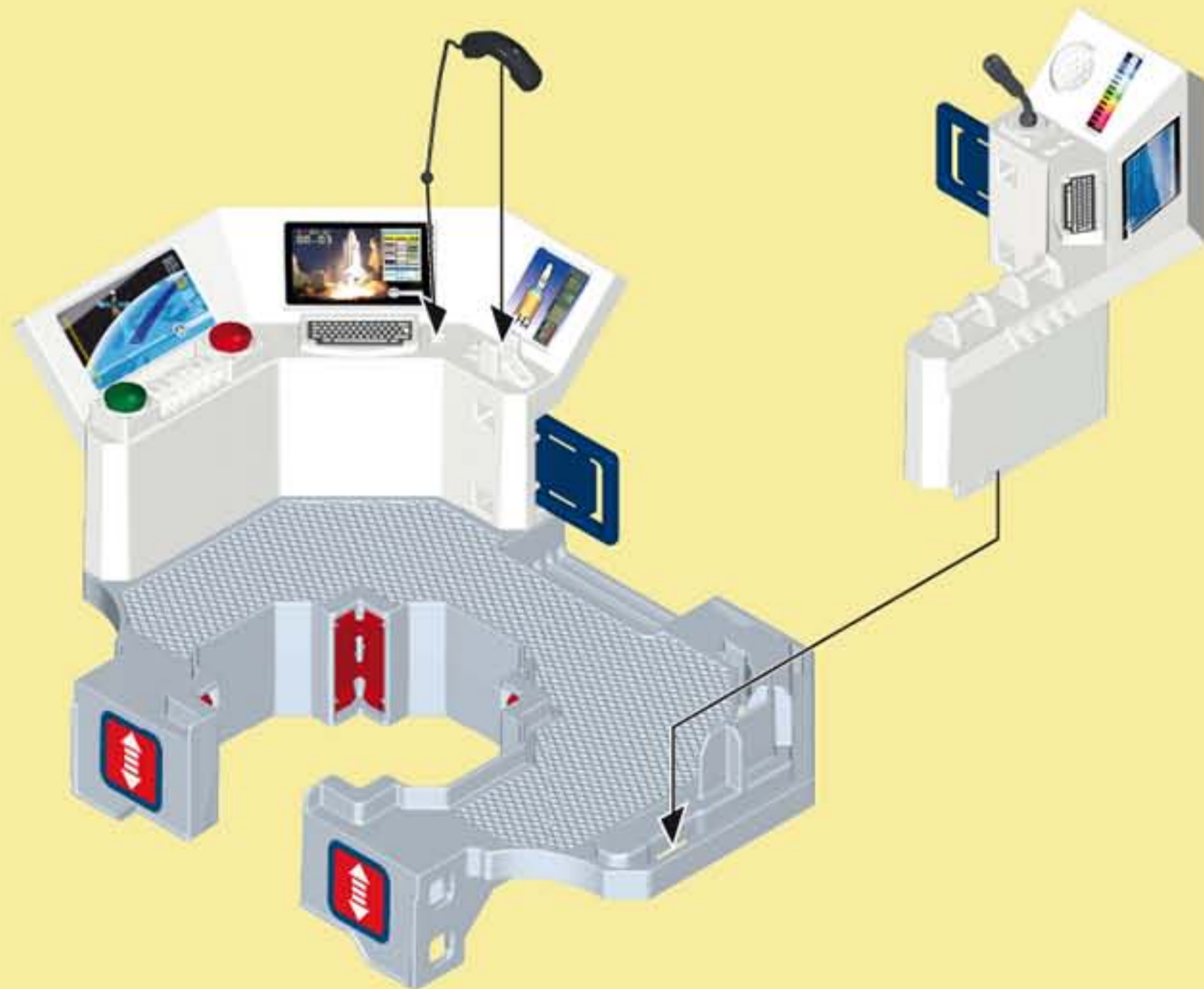

4

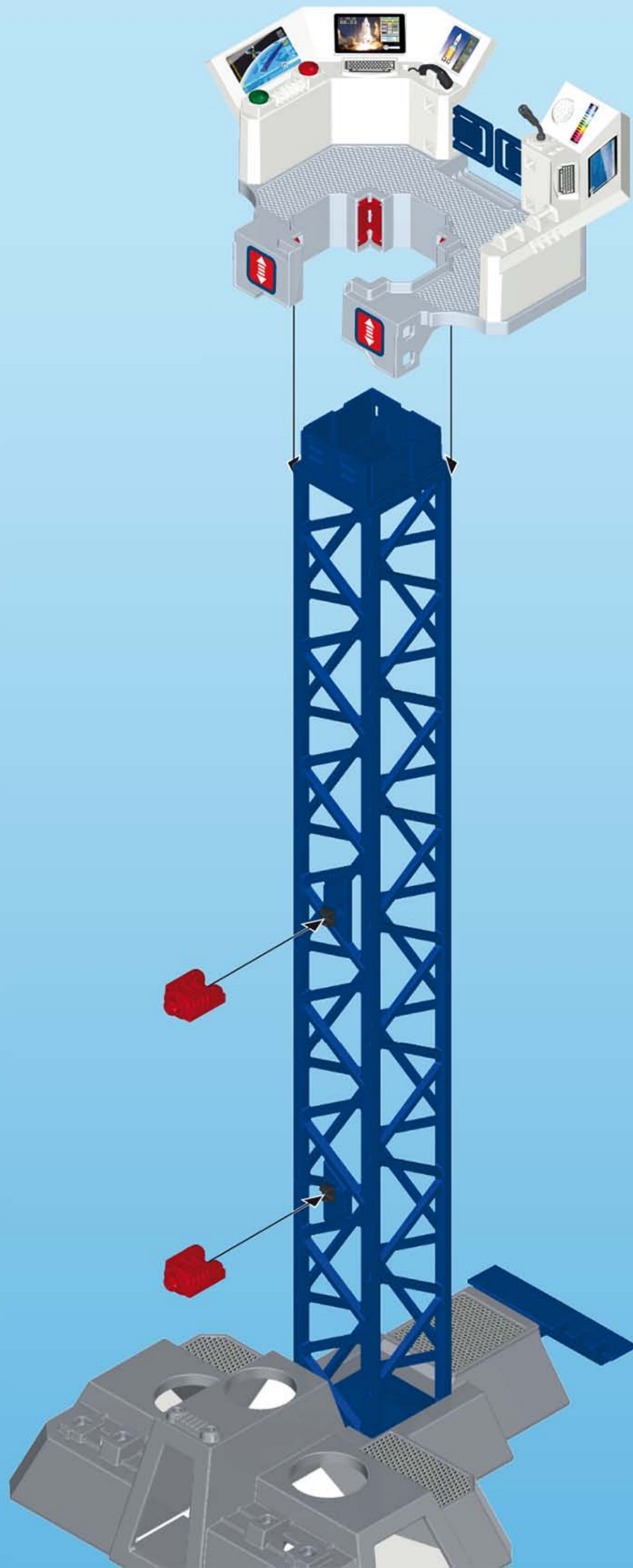

2x

5

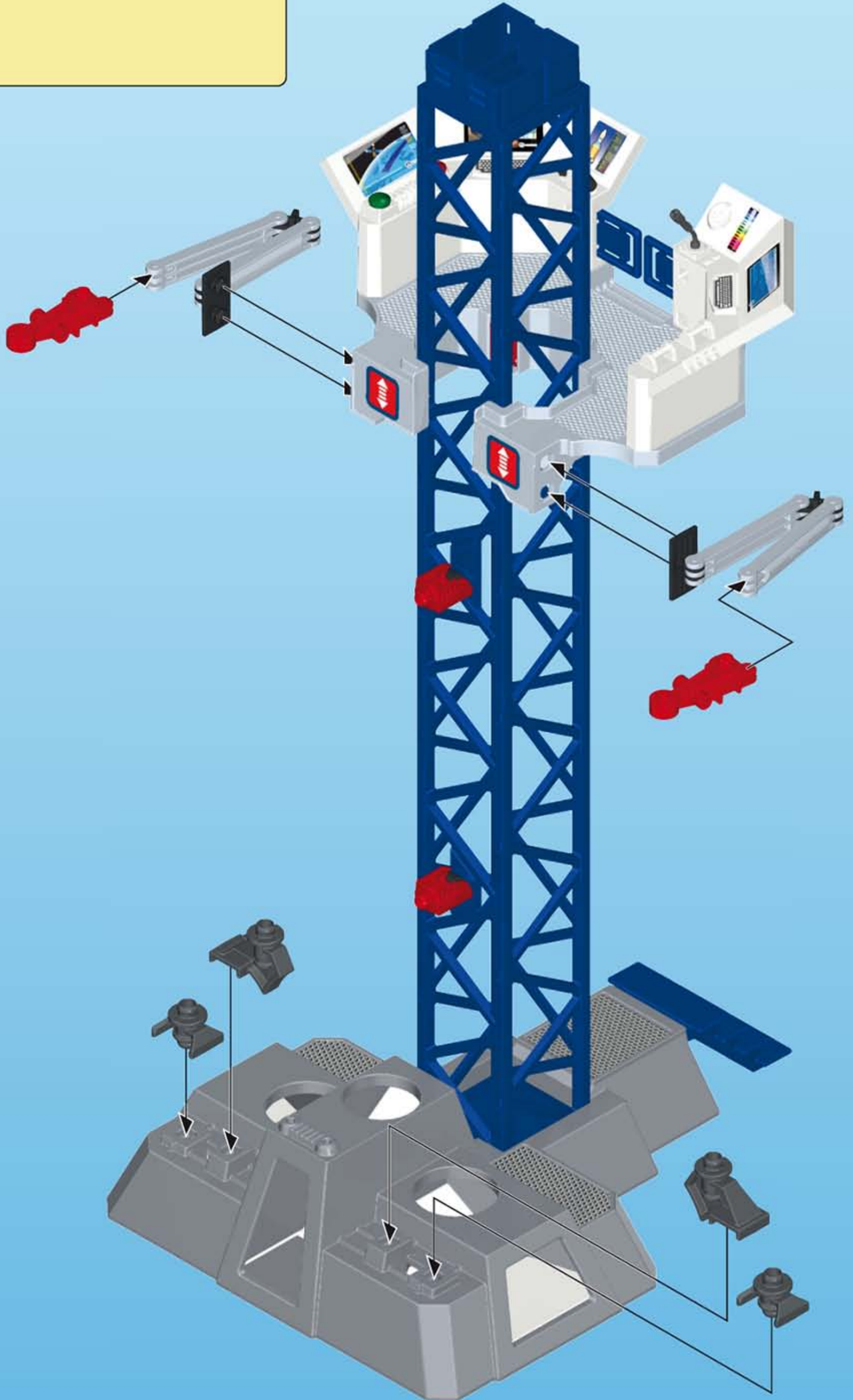

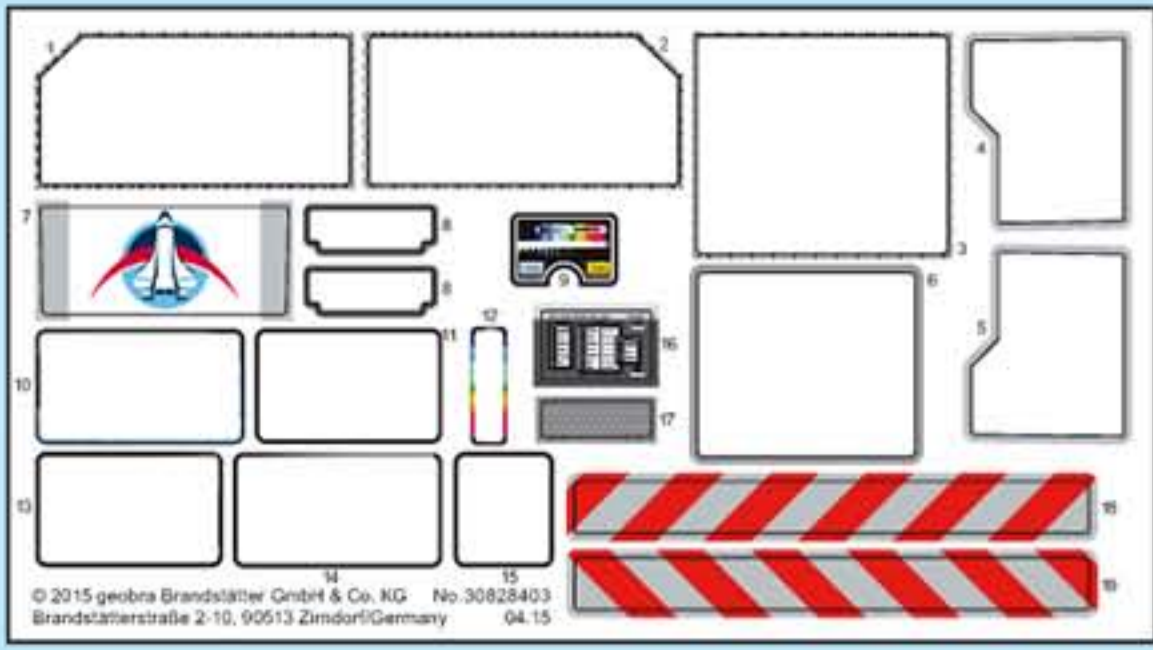

6

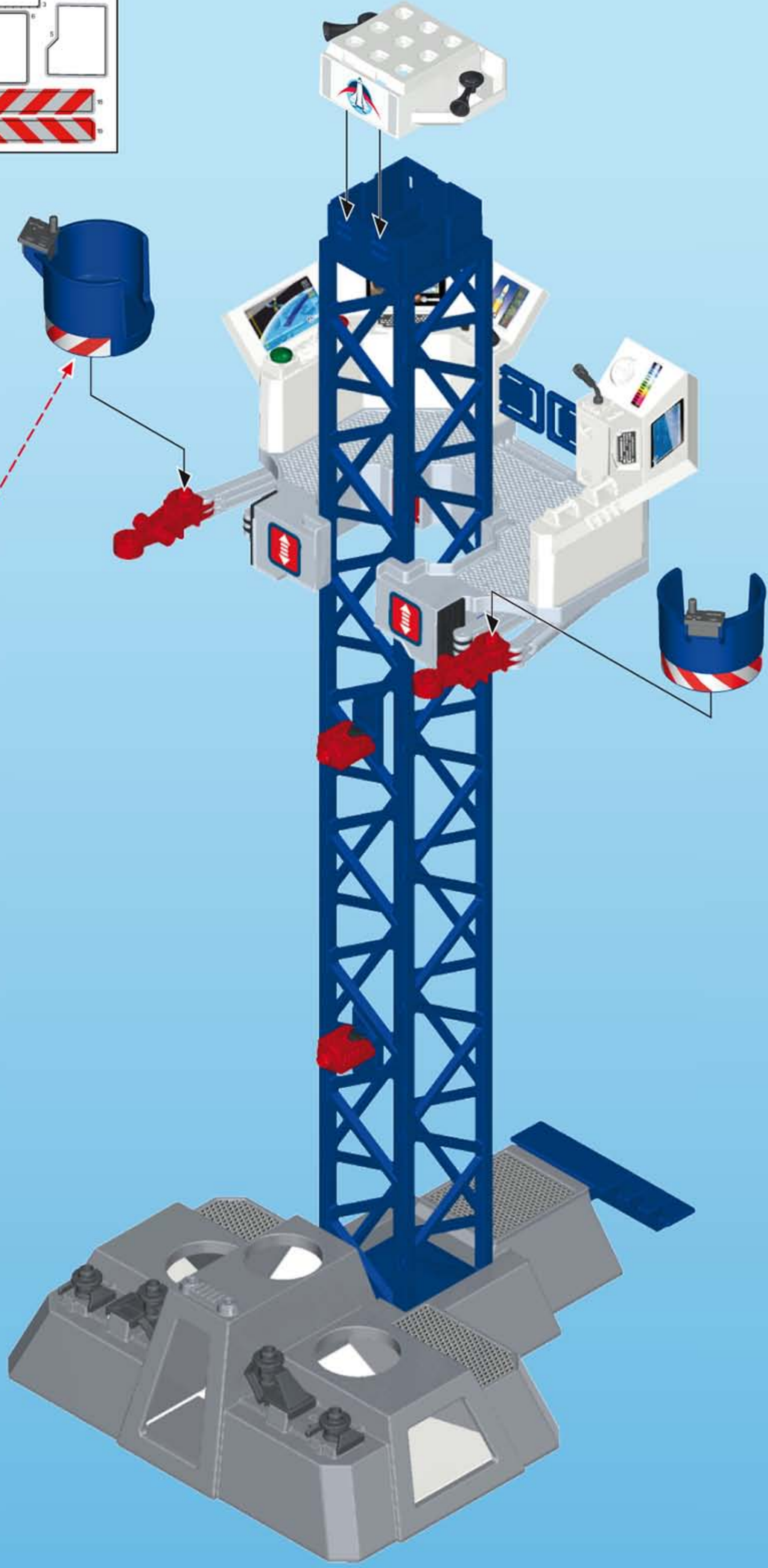
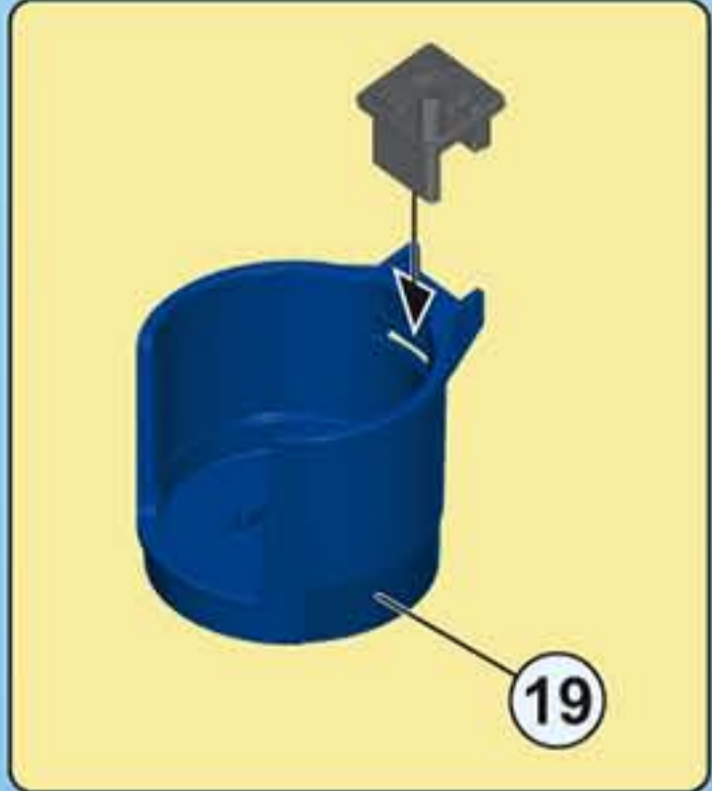
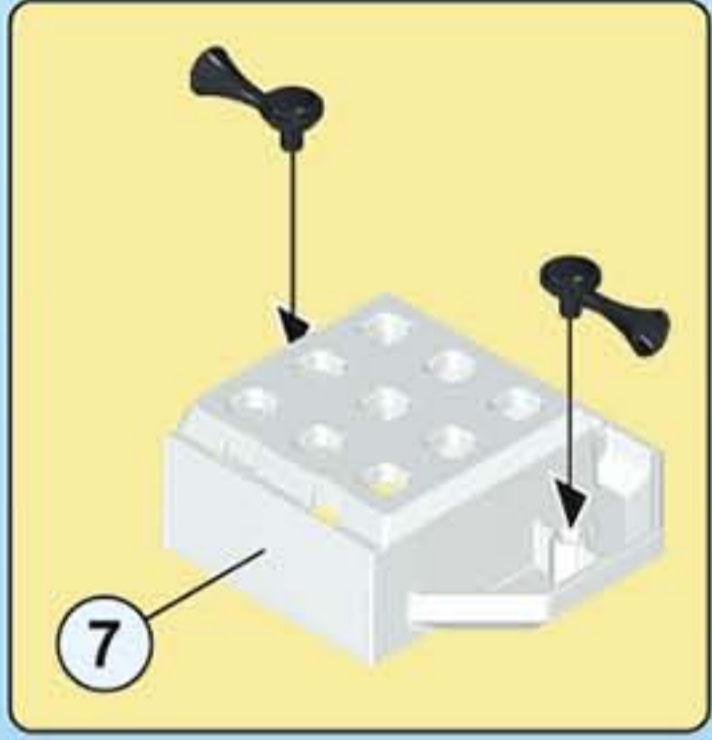

1

+ 2x Mignon 1,5V
R6 • LR6 • AA -

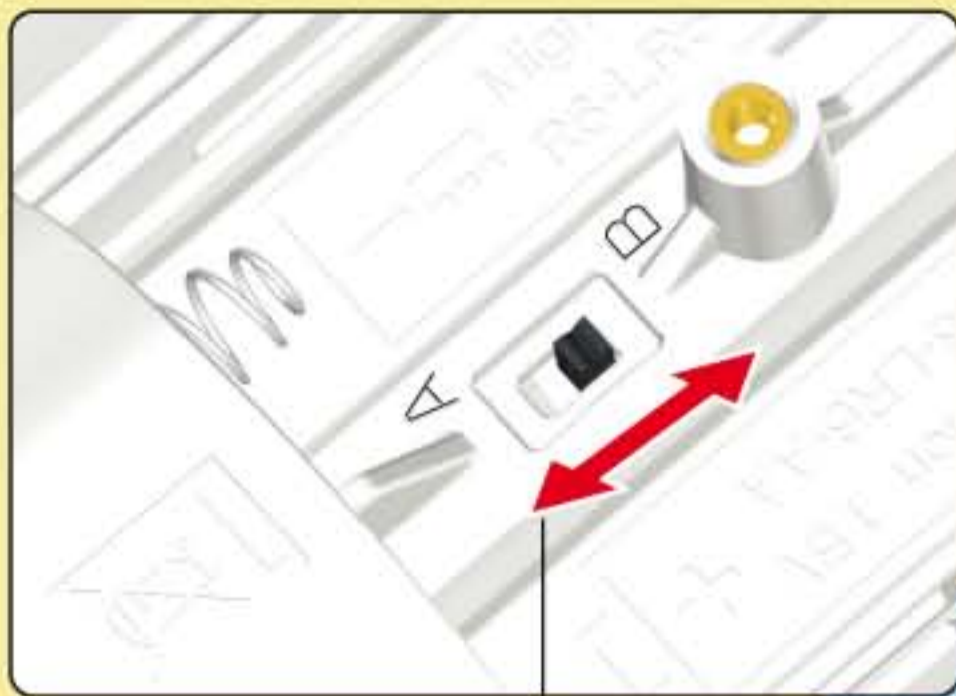

A/B

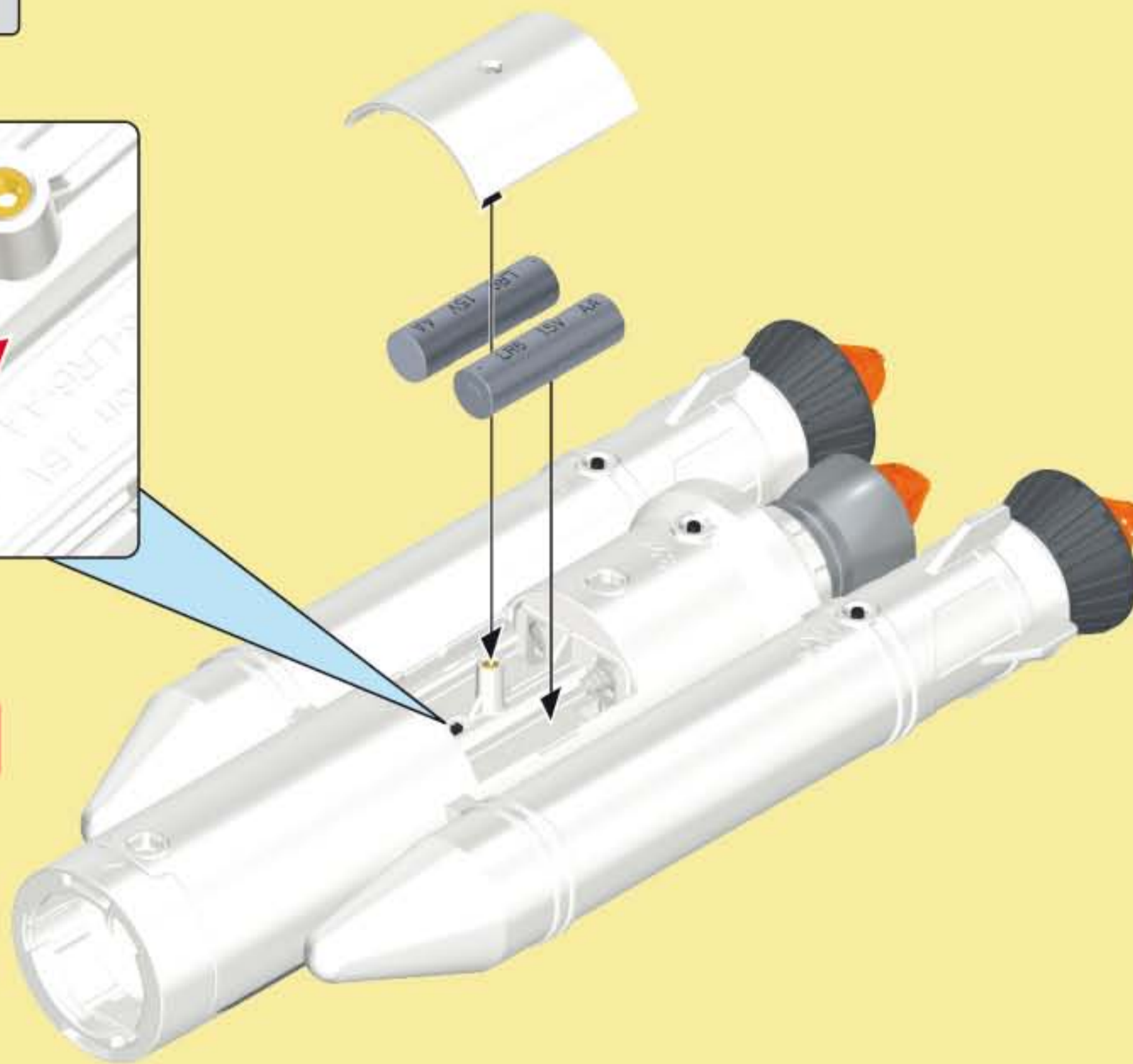

2

An / Aus
On / Off
Marche / Arrêt

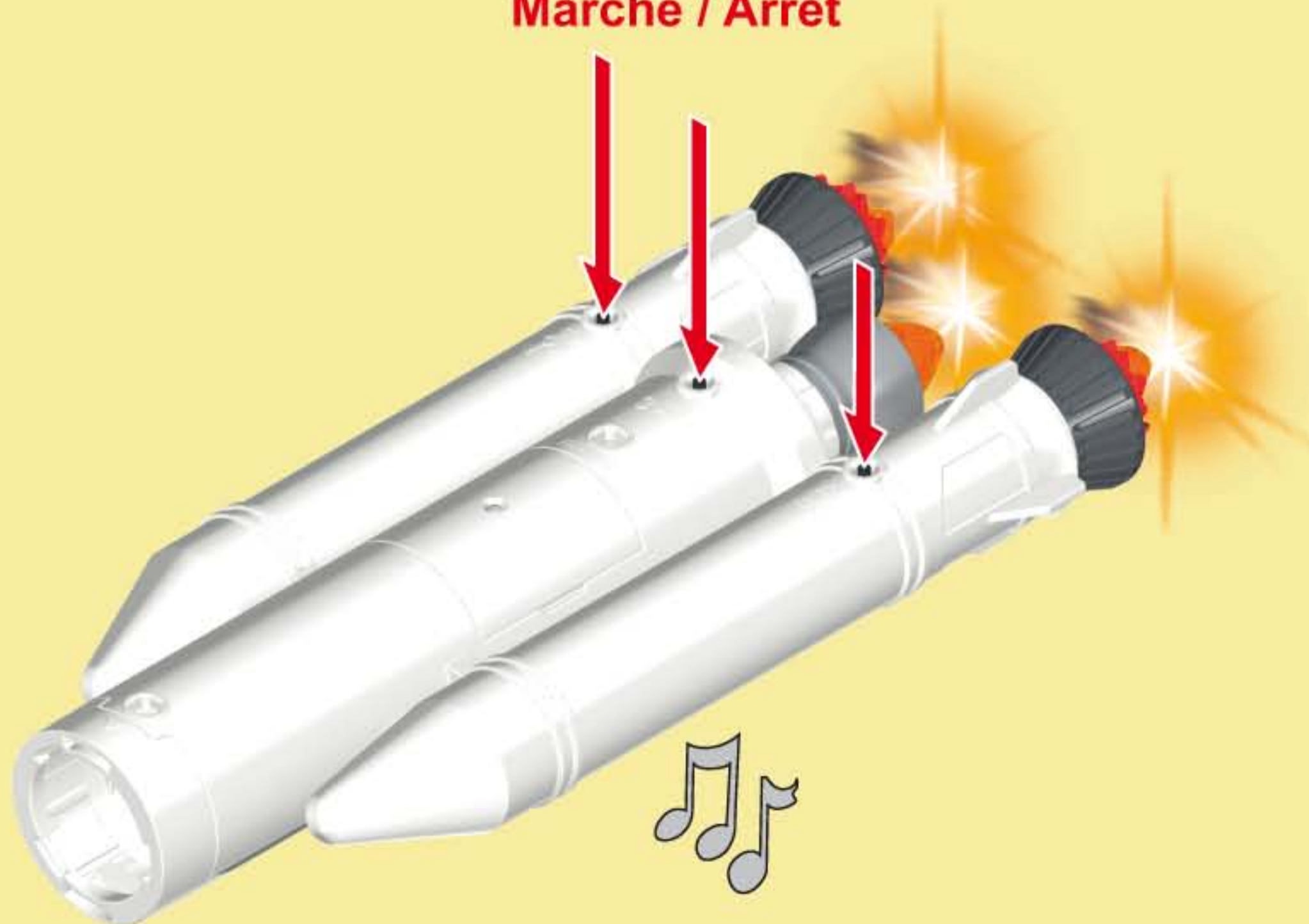

7

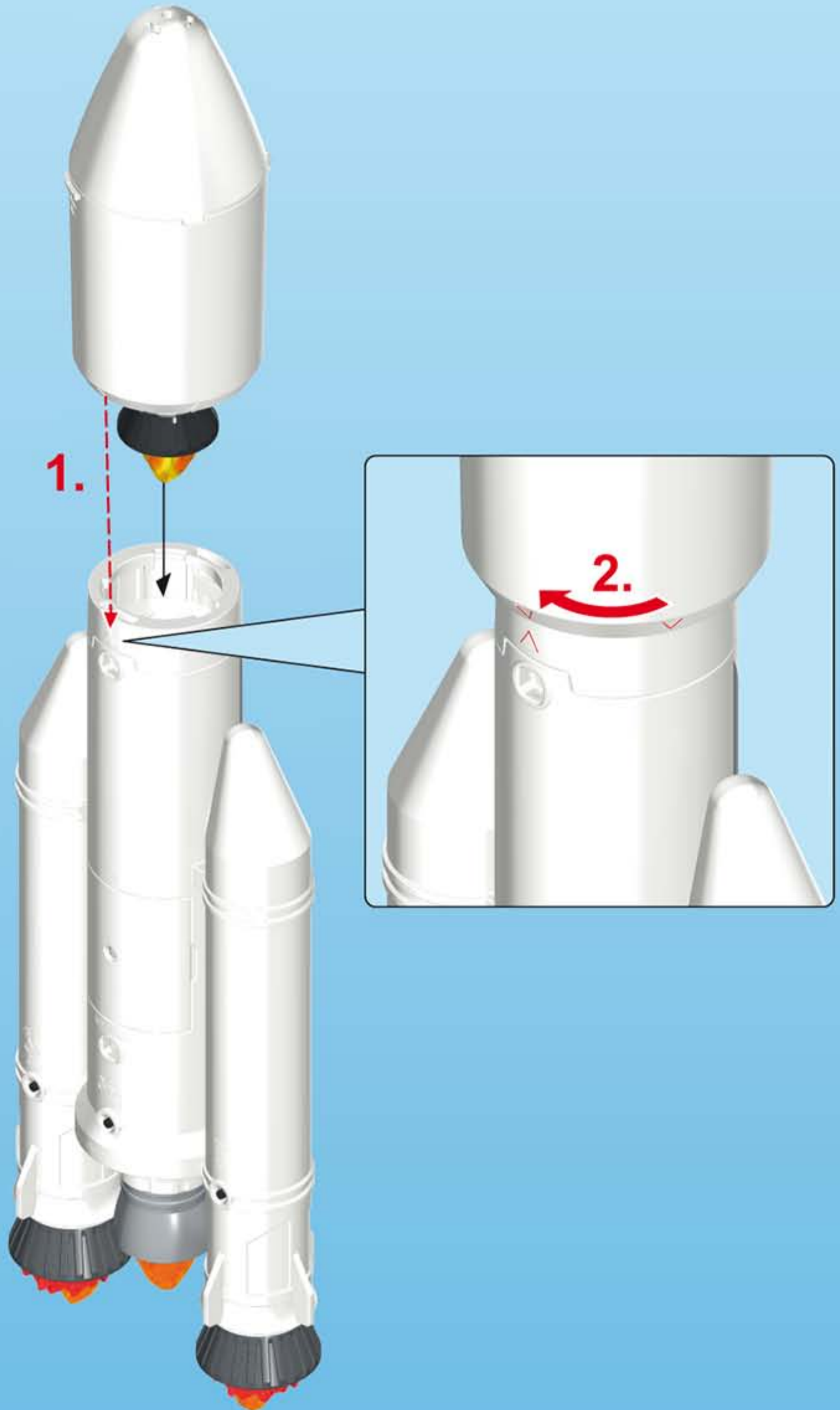
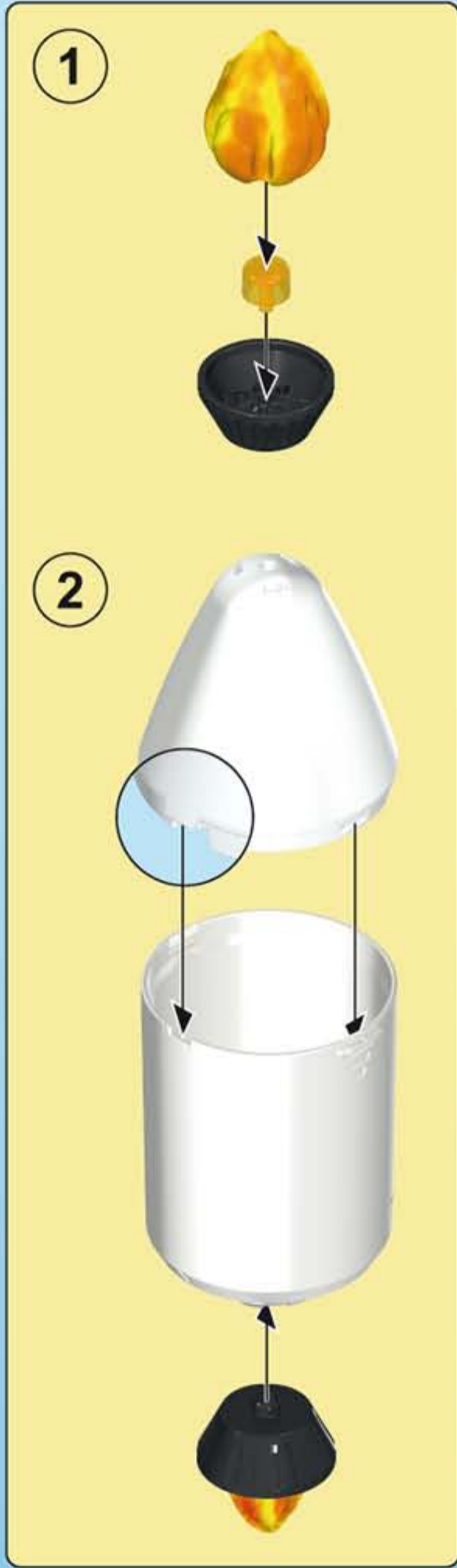

8

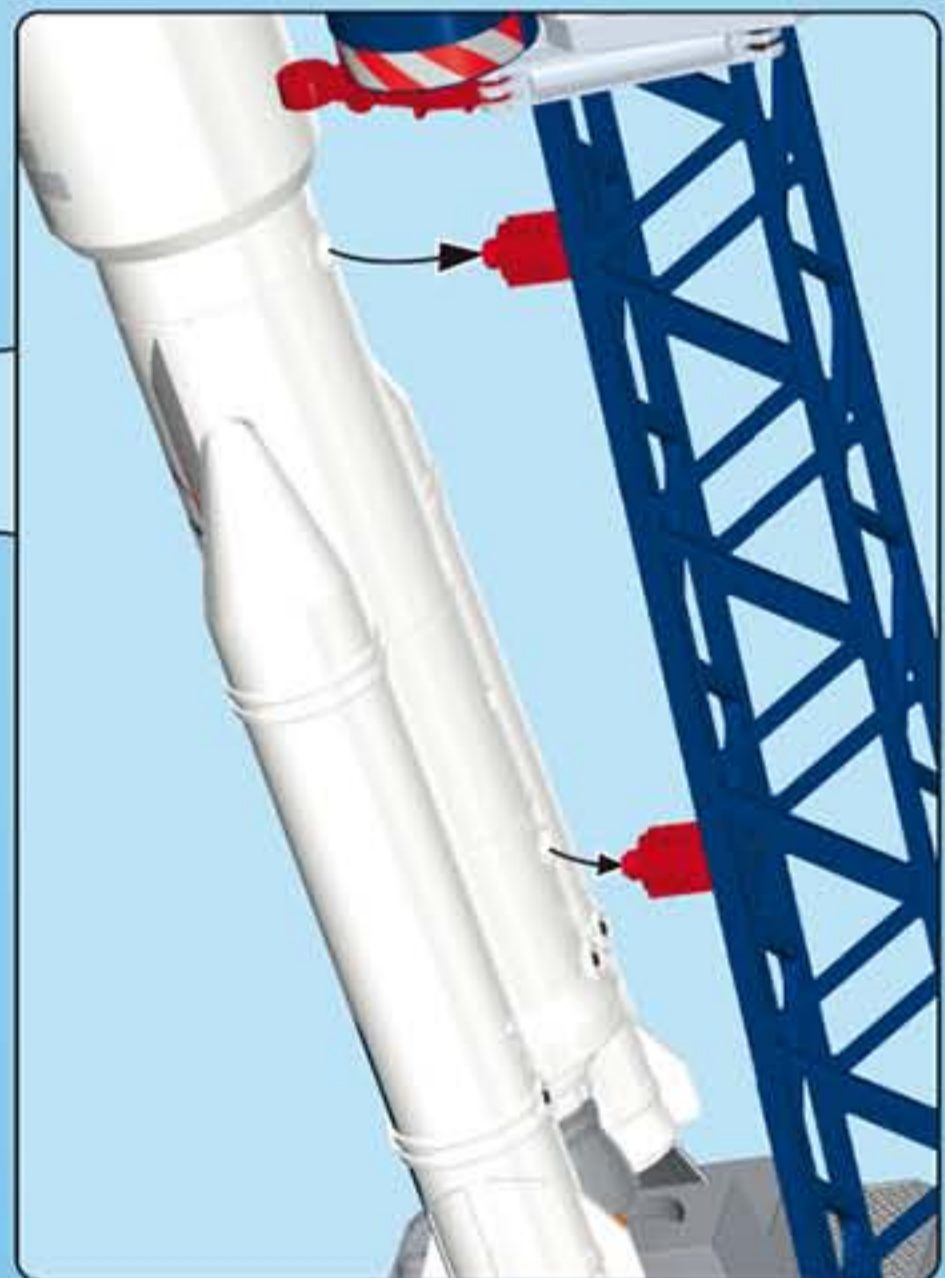
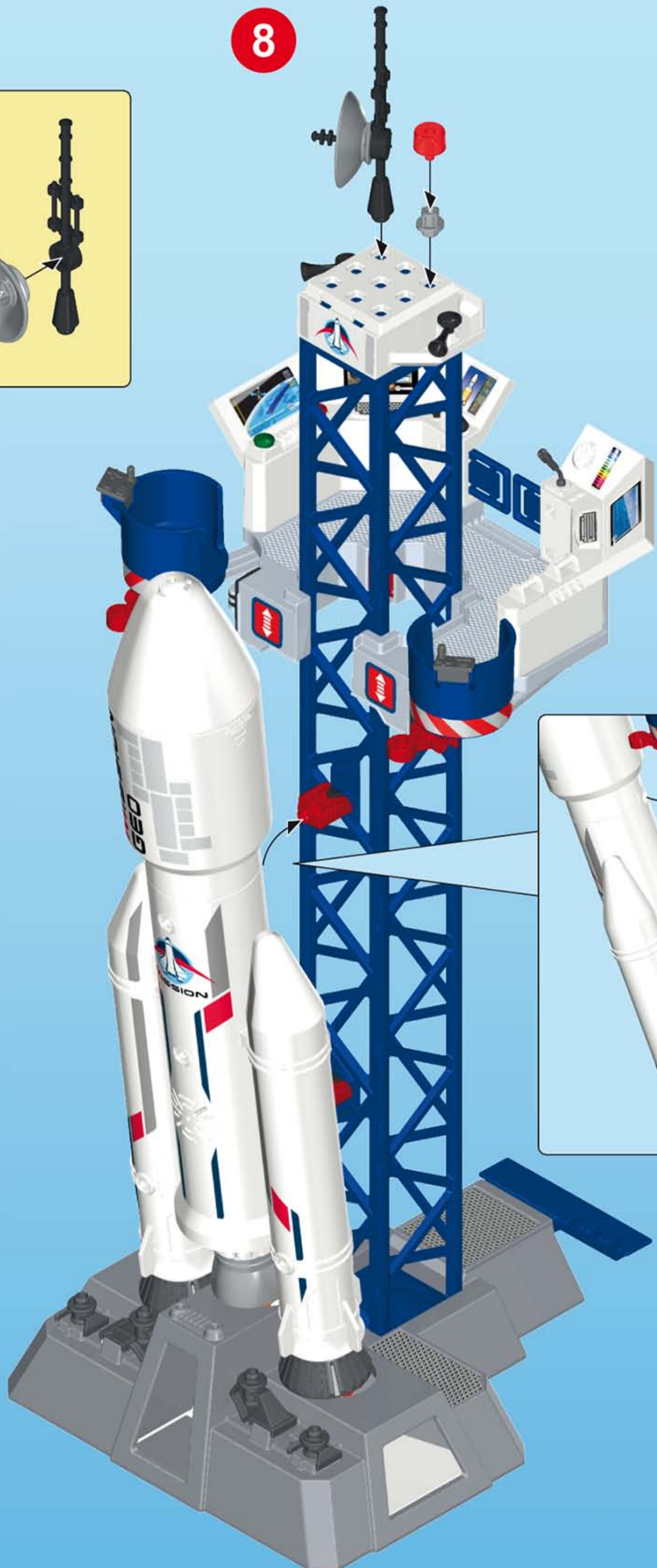
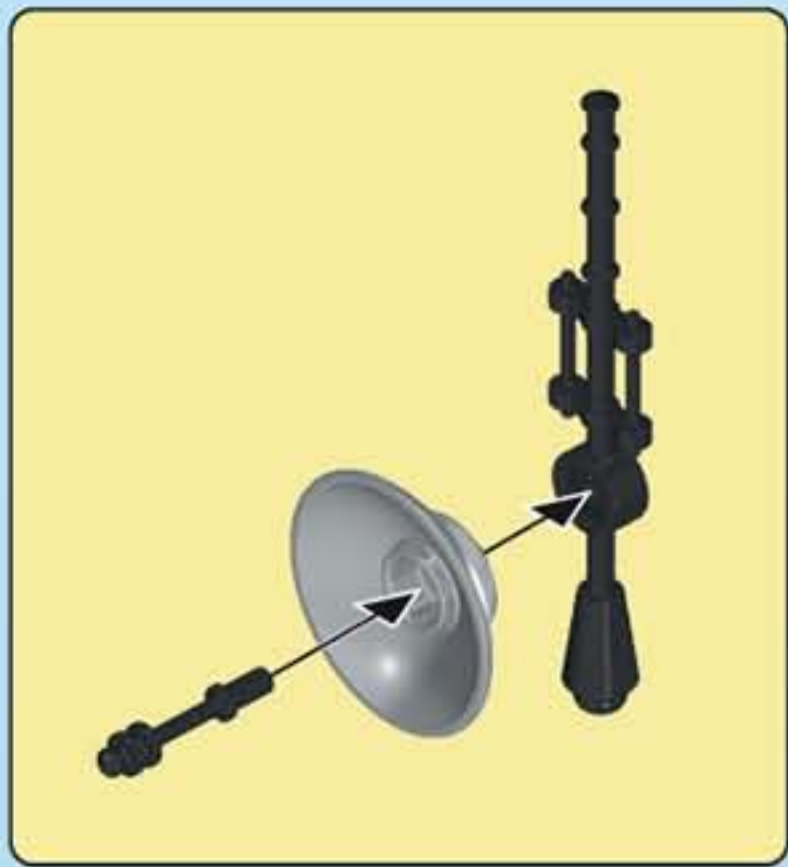

9

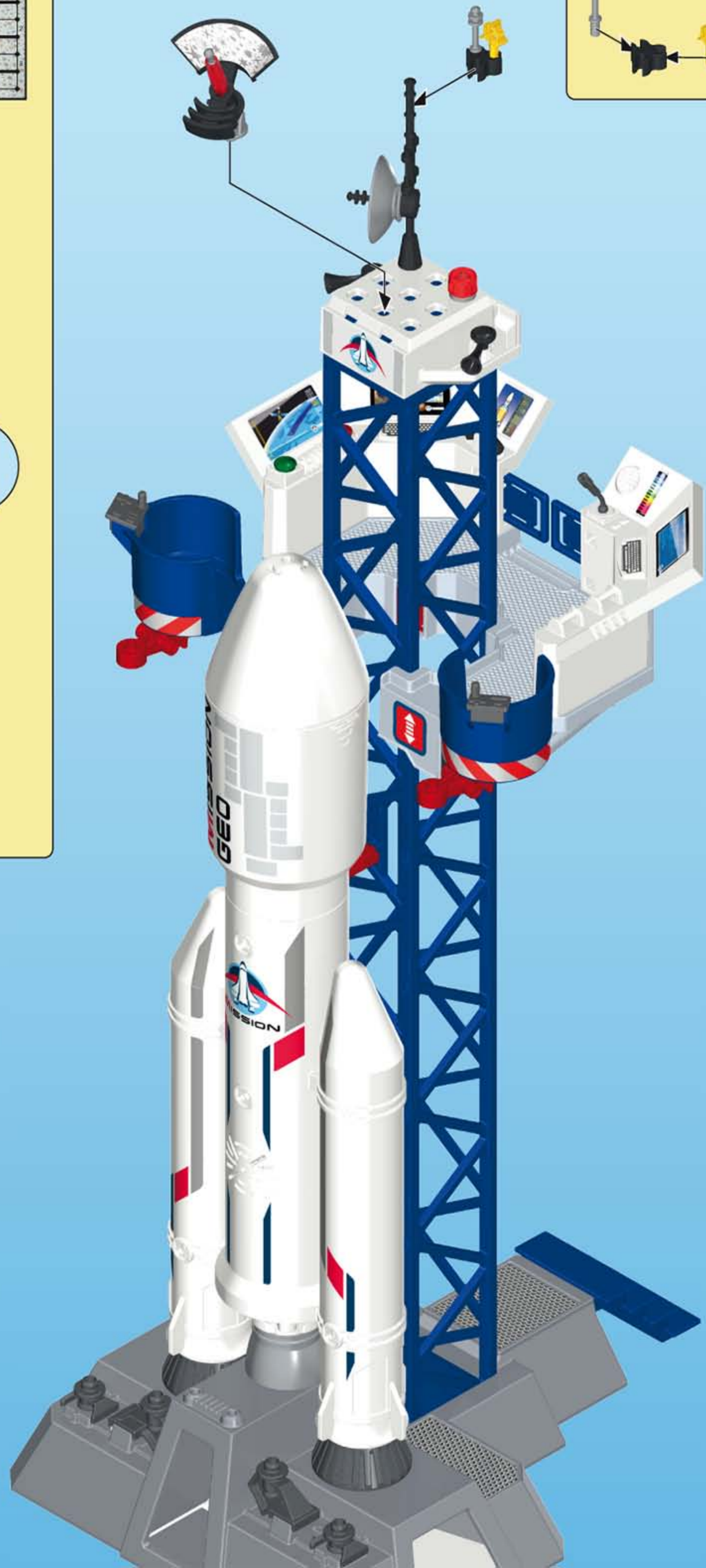
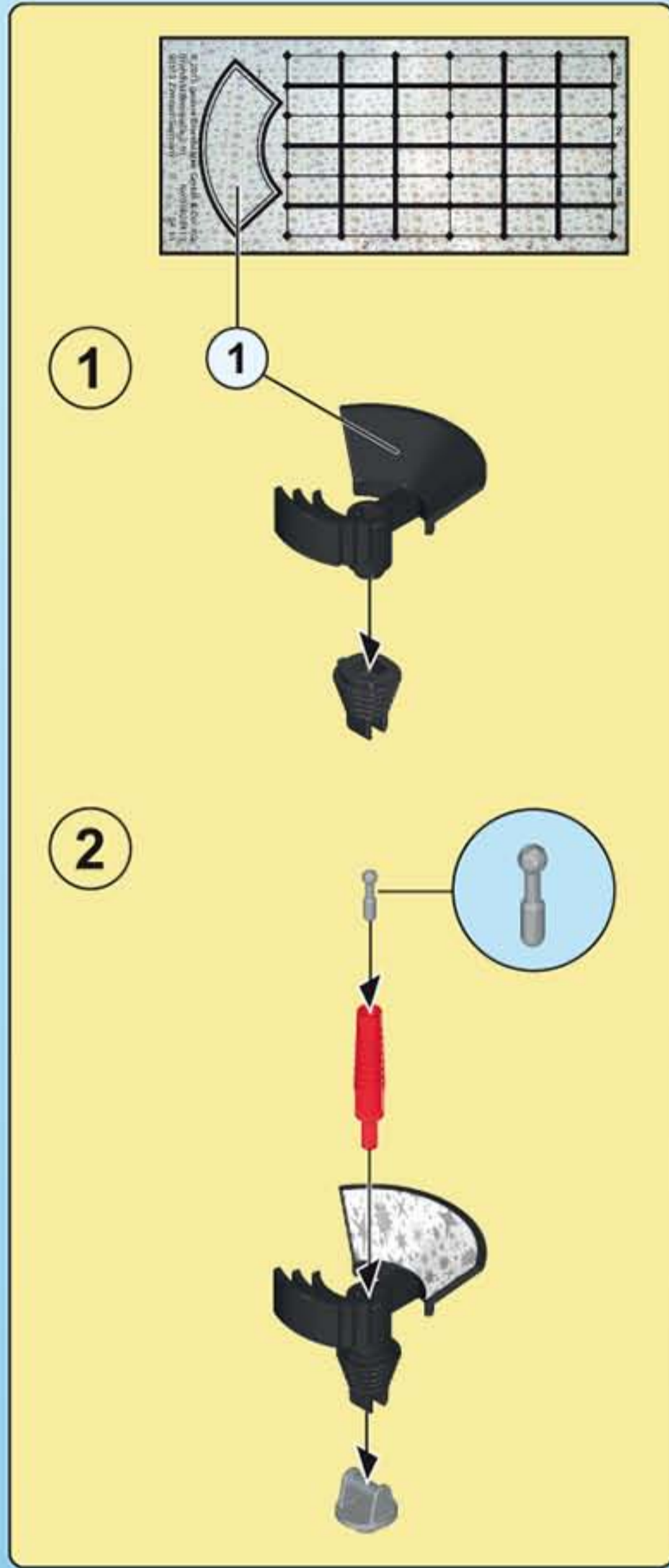
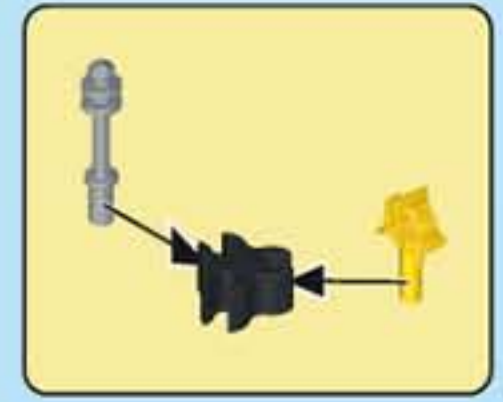

10

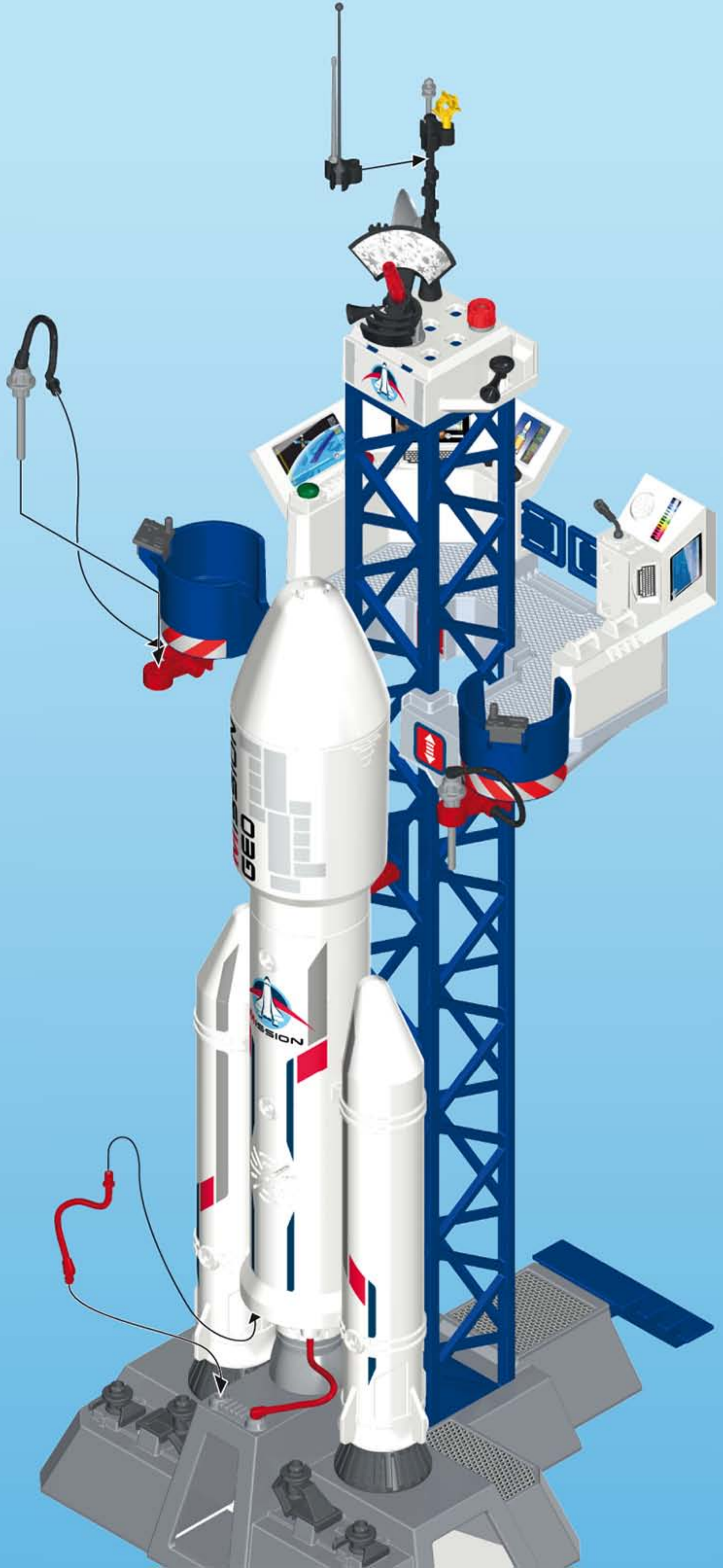
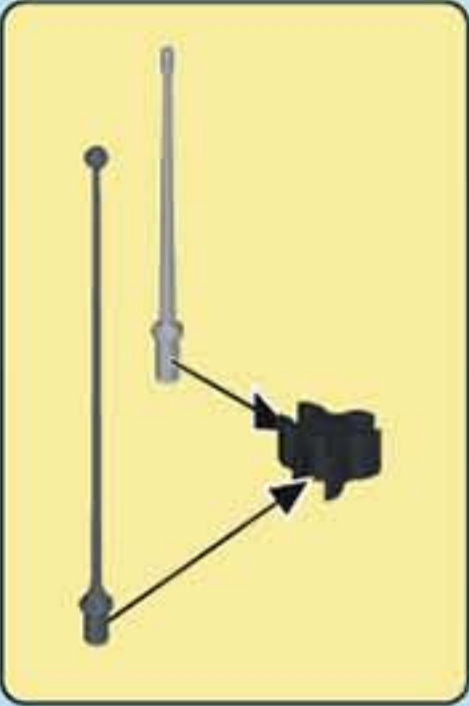

1

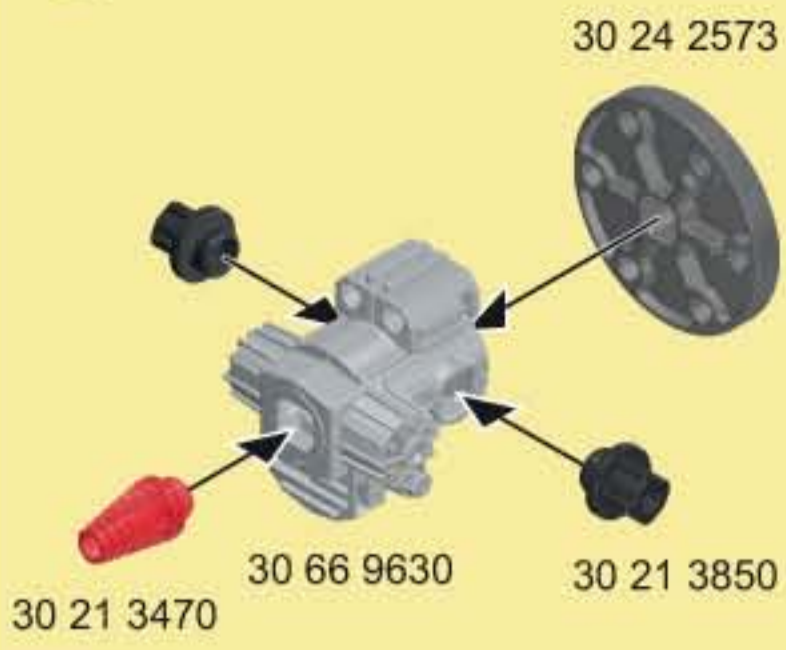

2

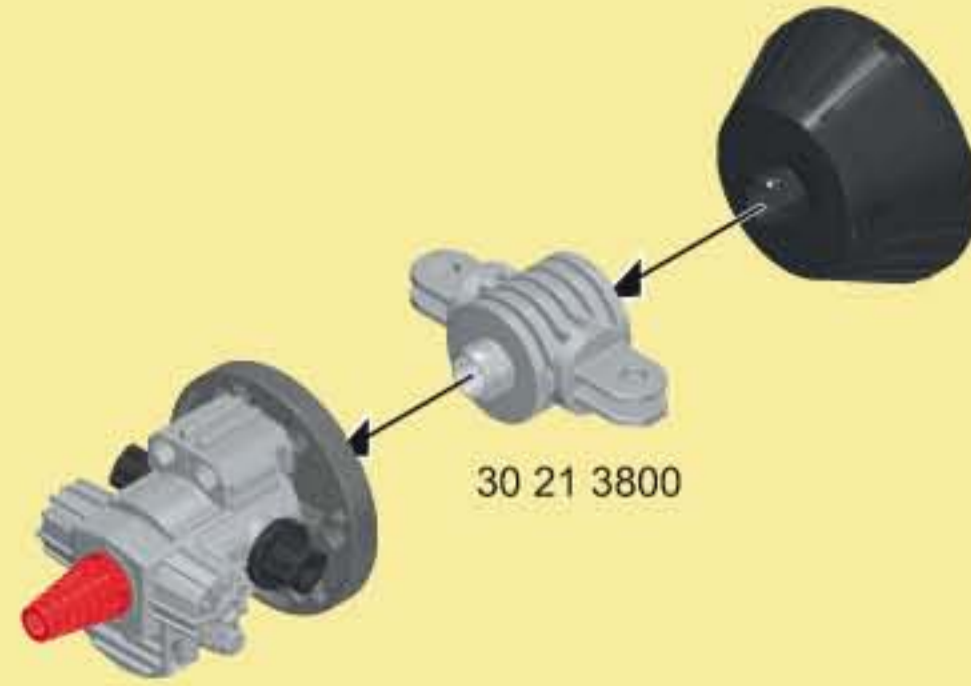

3

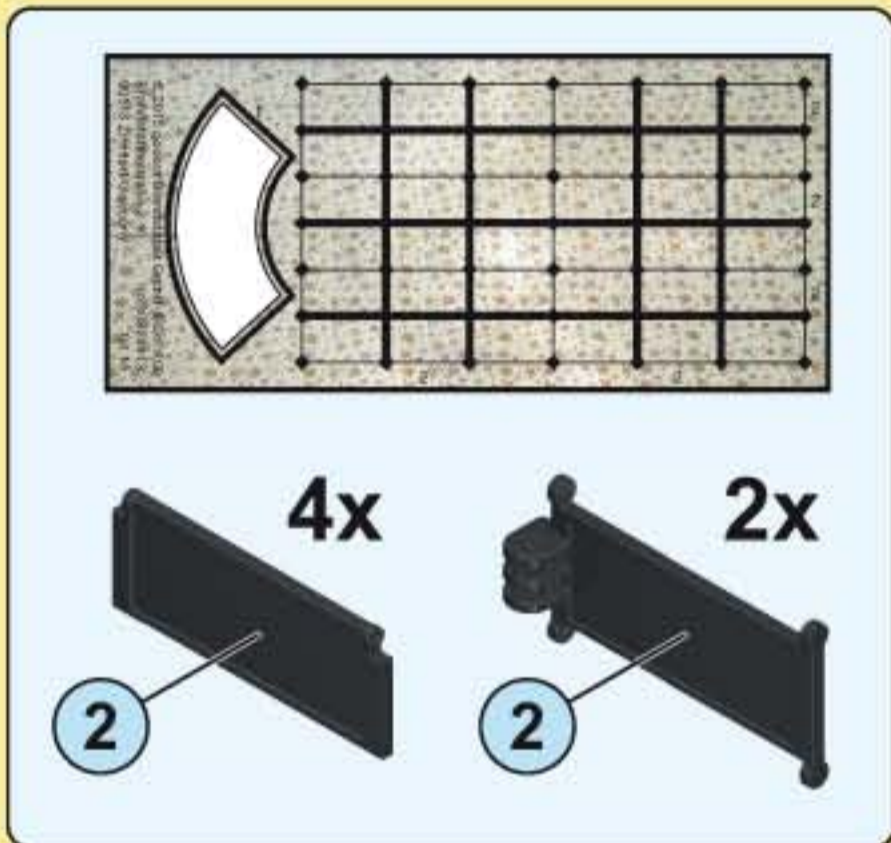

2x

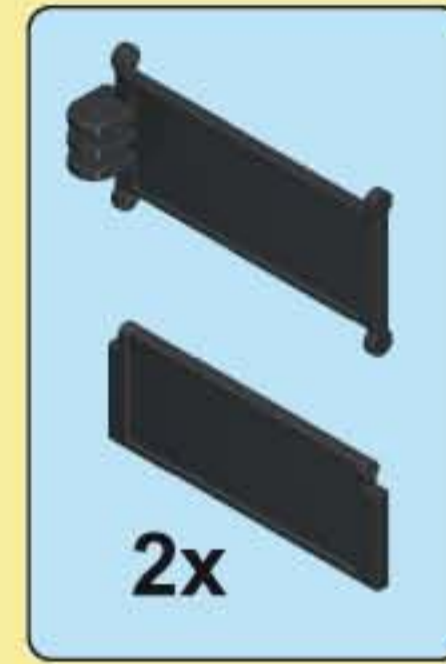
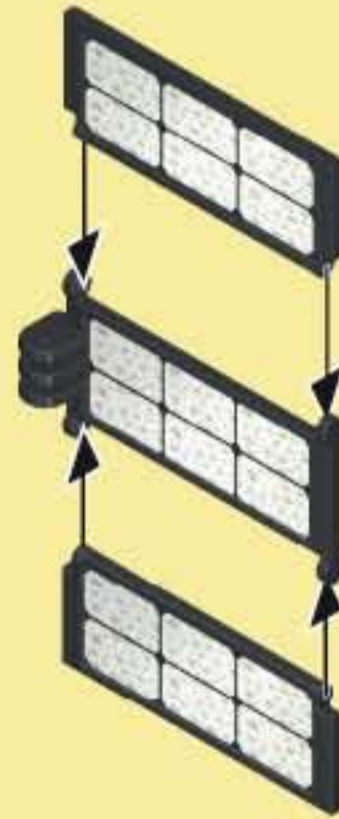

2x 30 61 3840

4

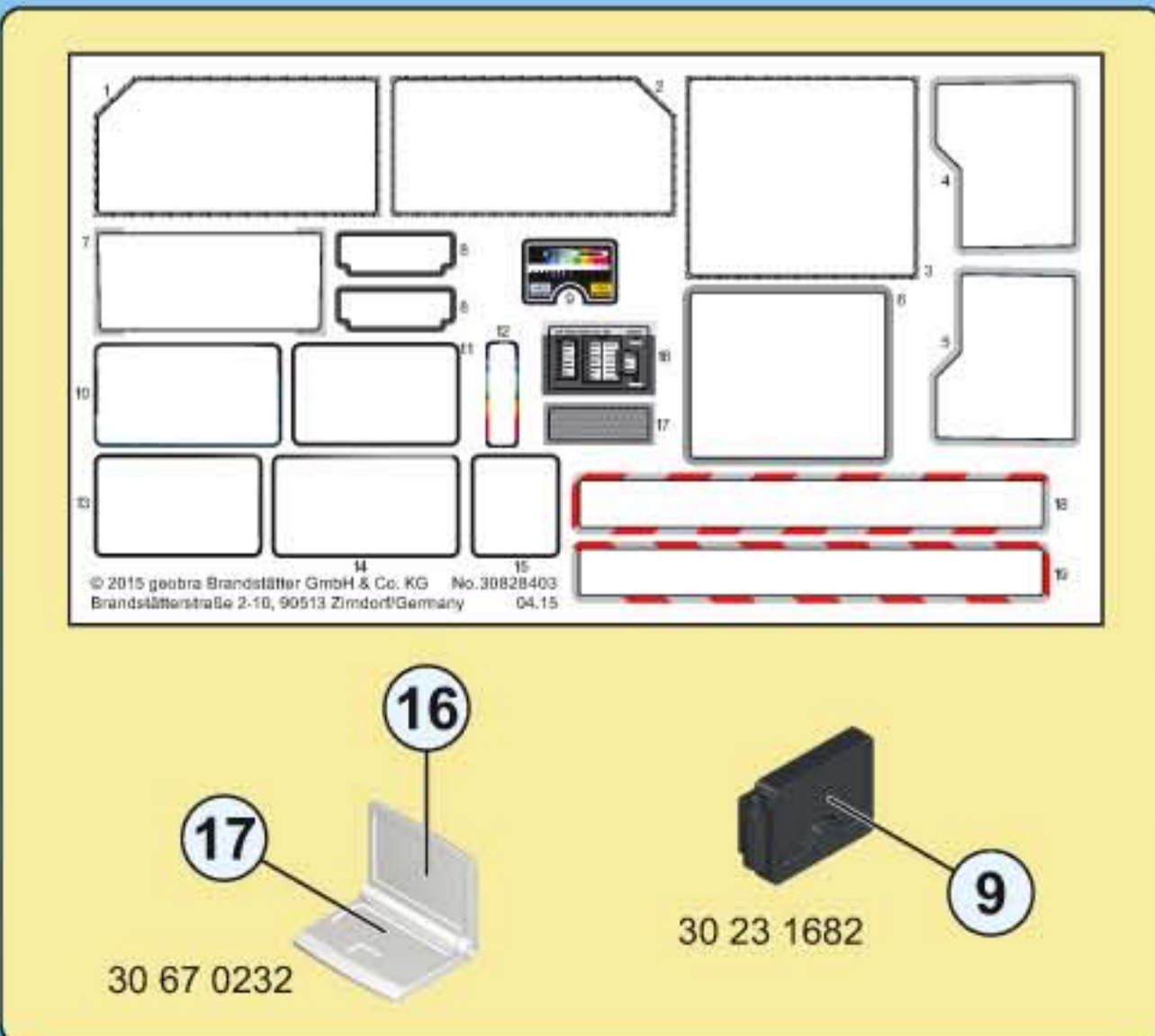
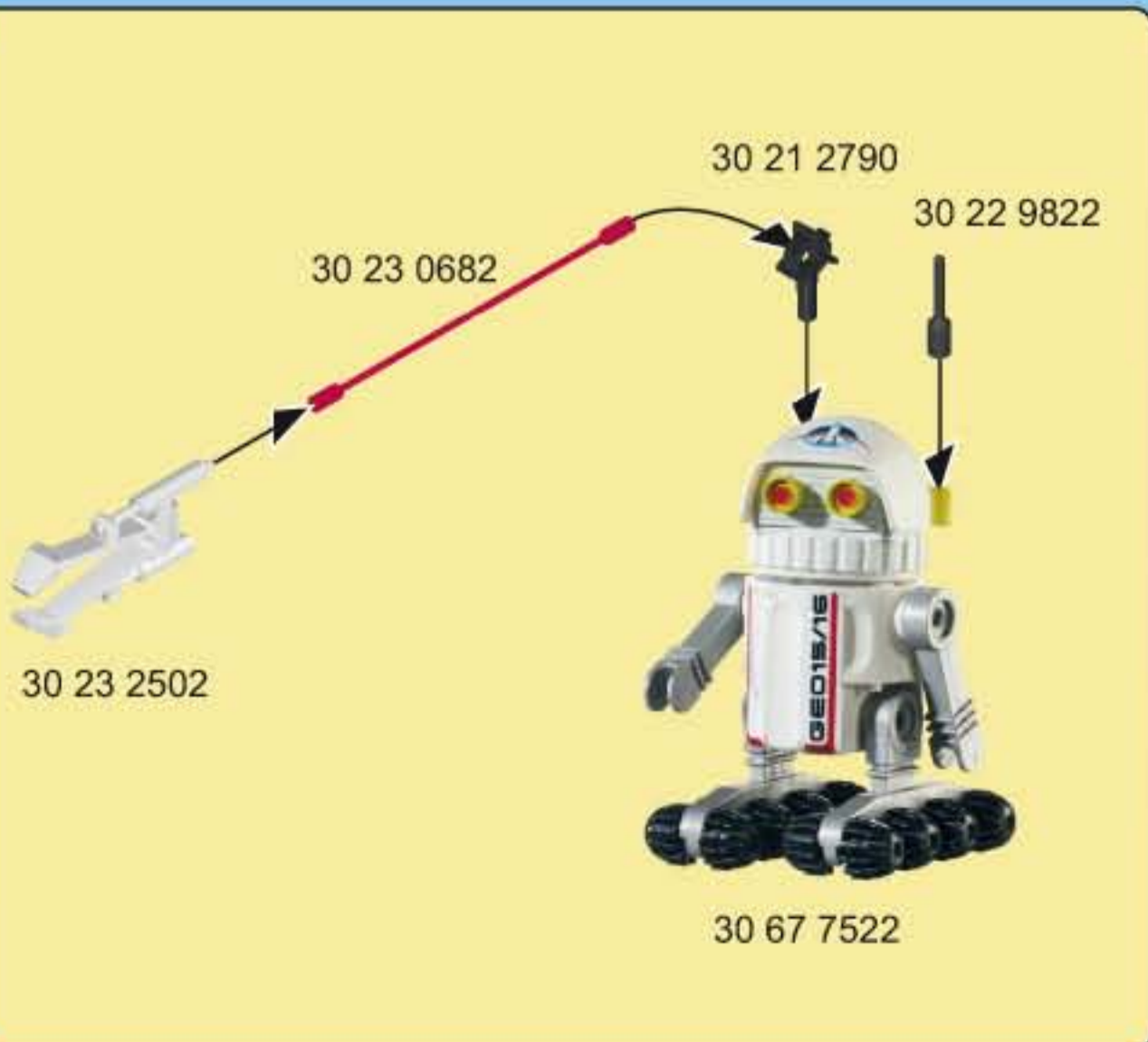
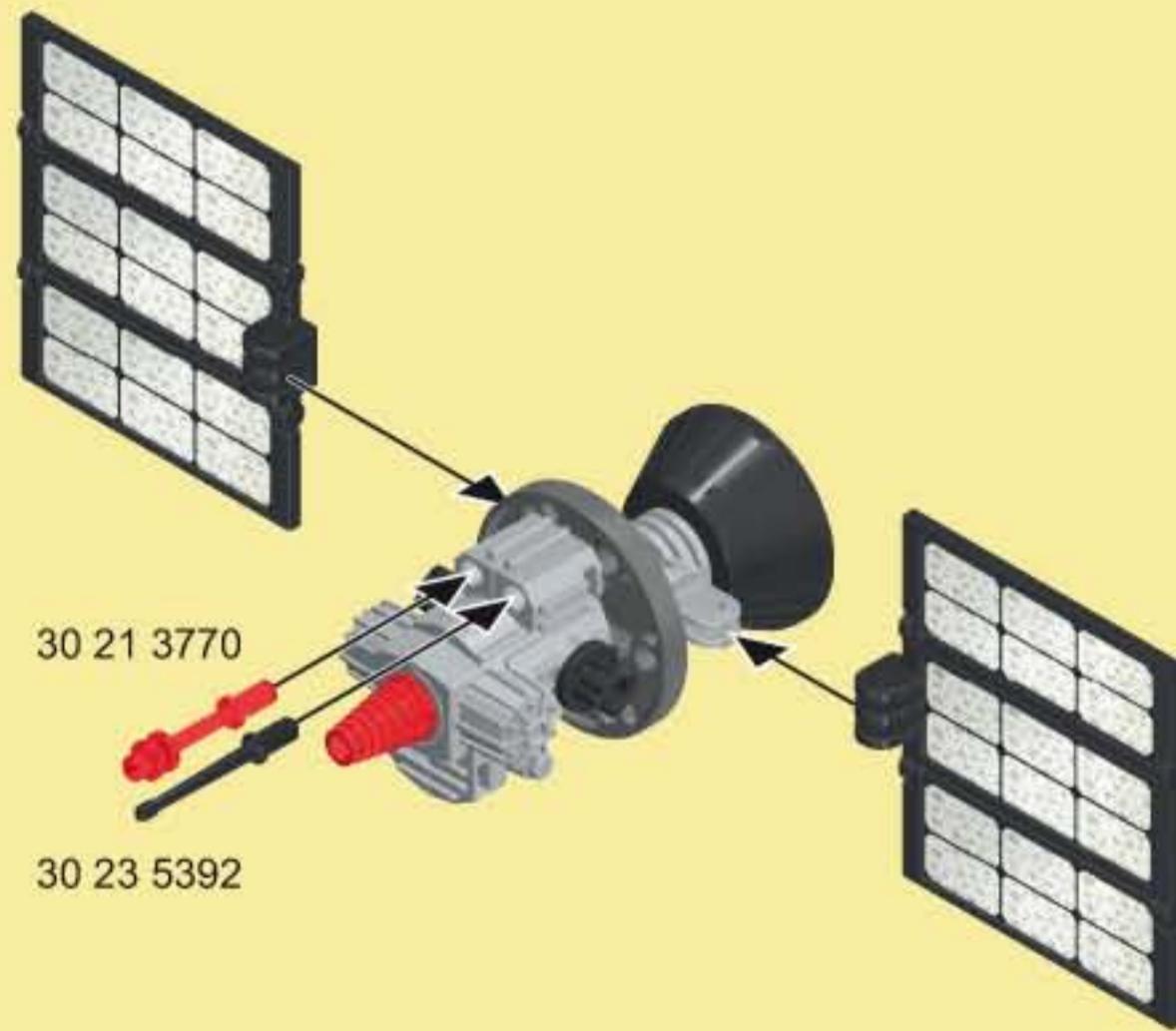

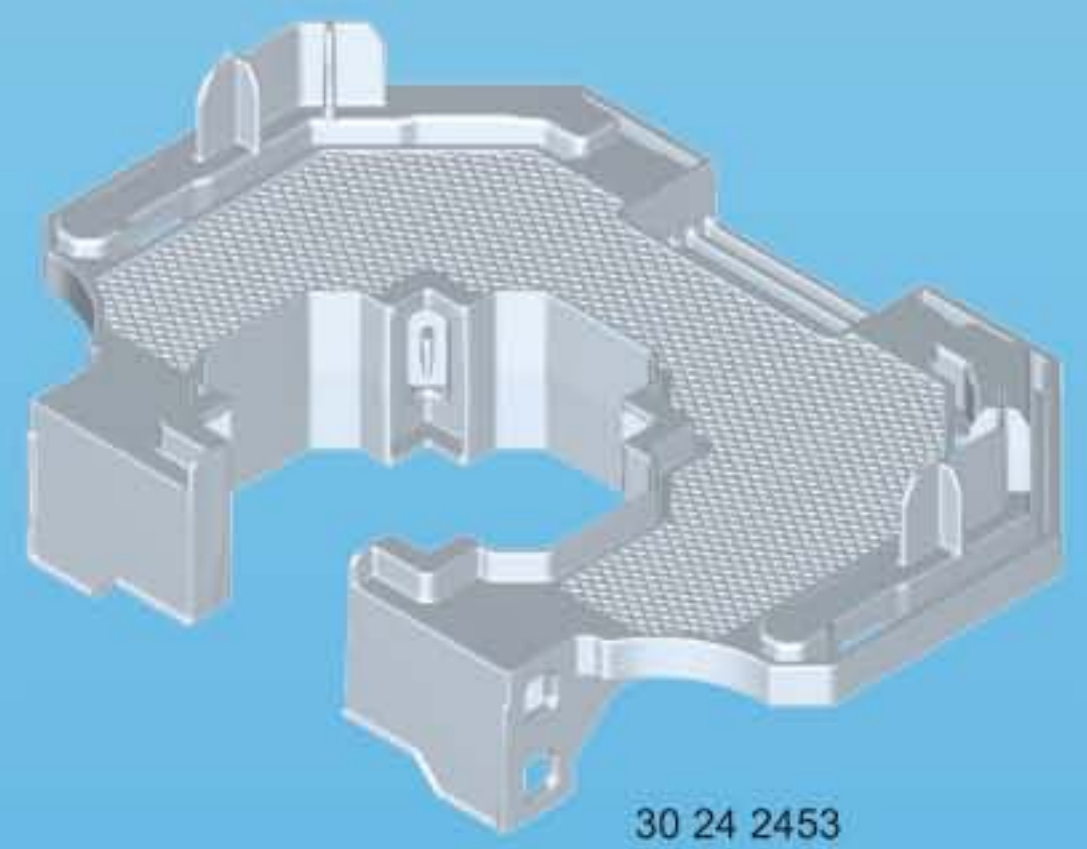
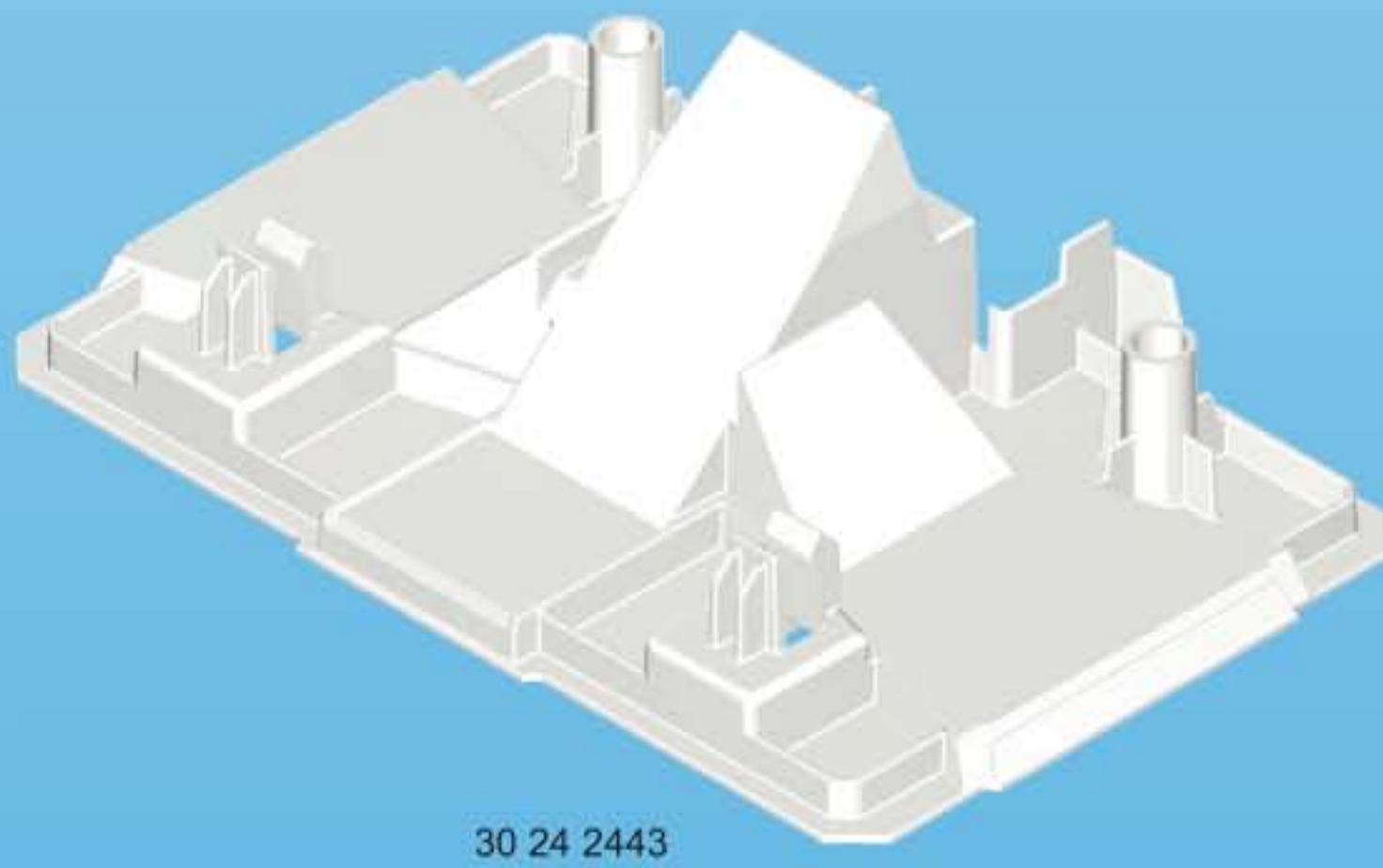
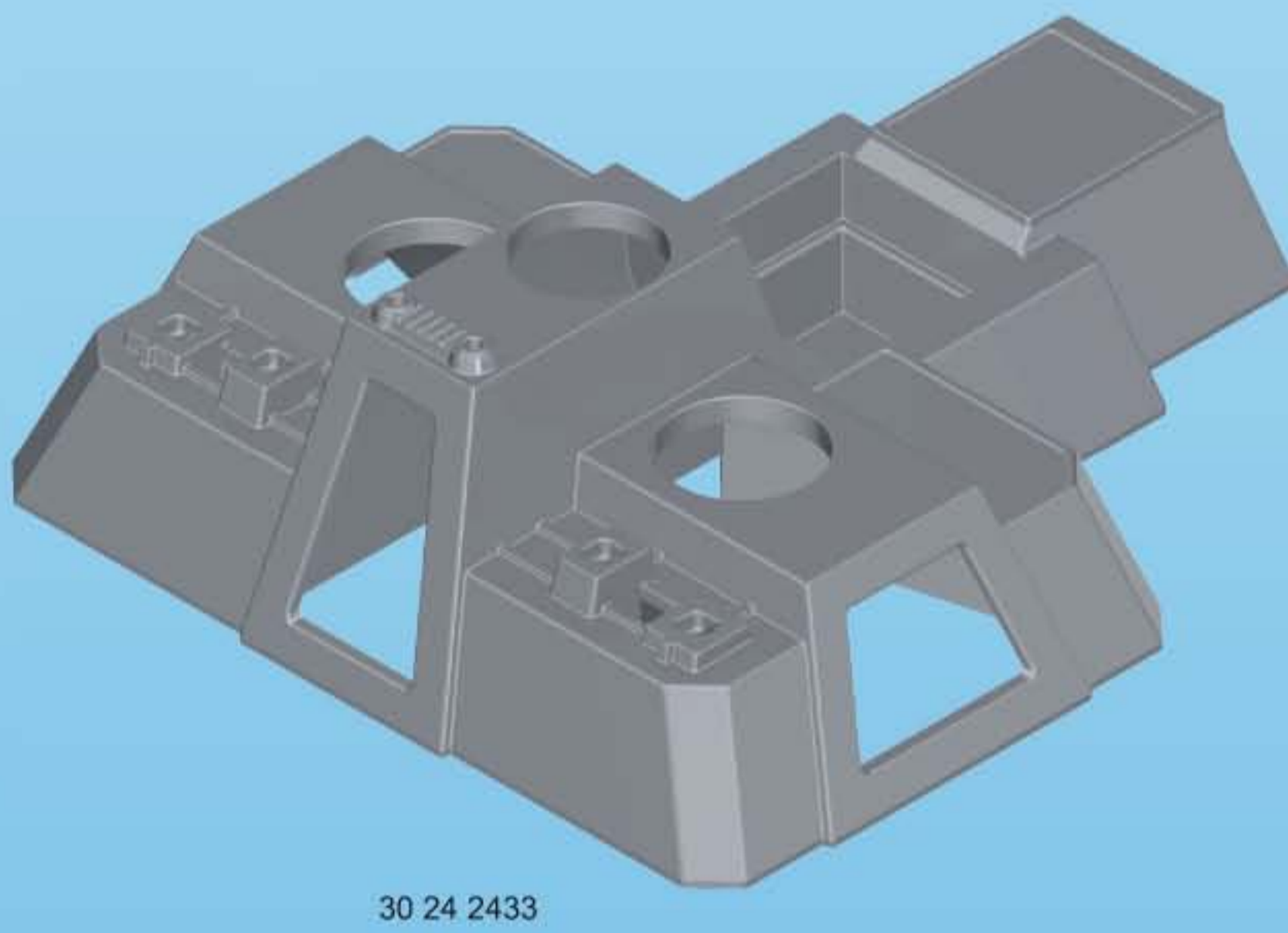
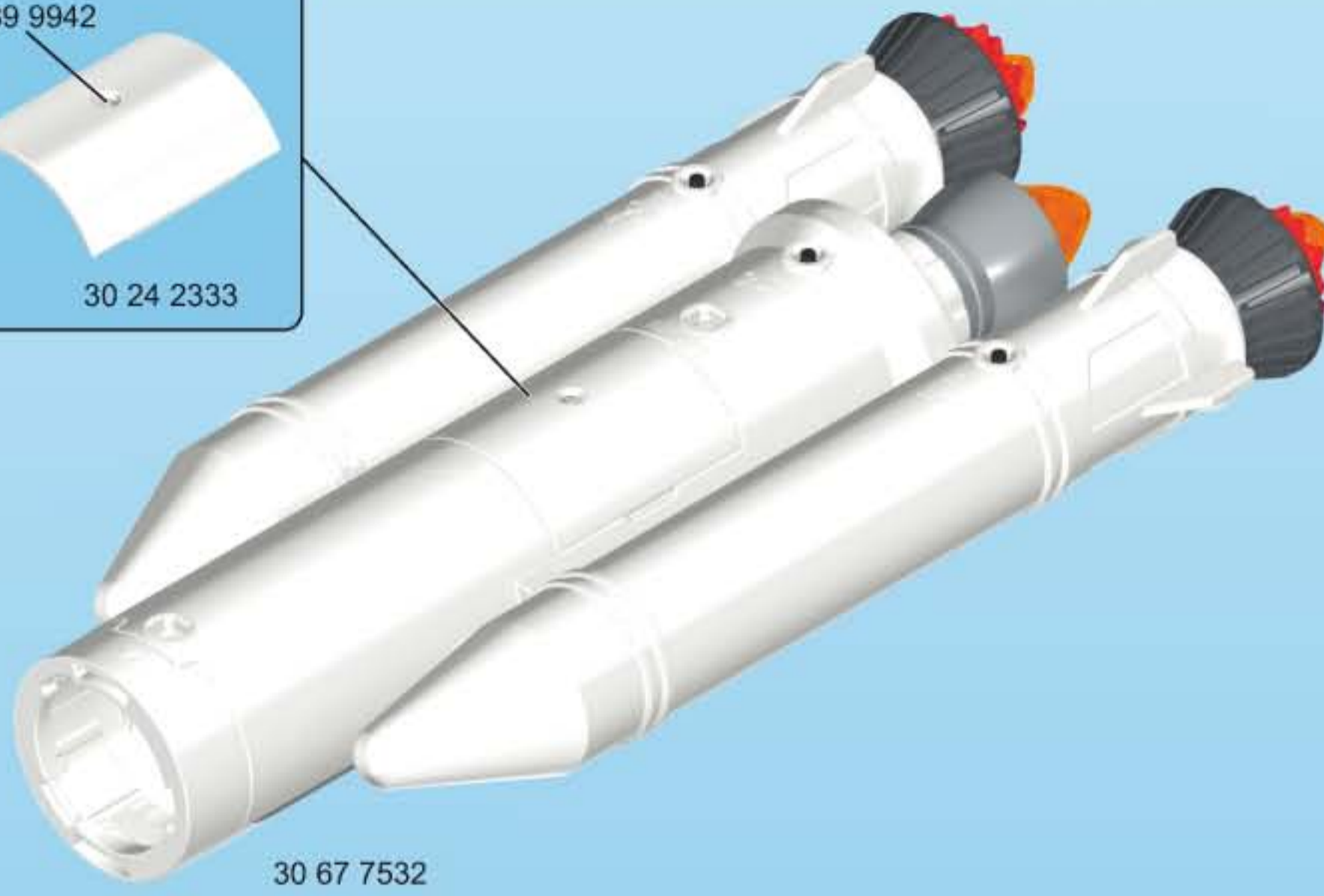
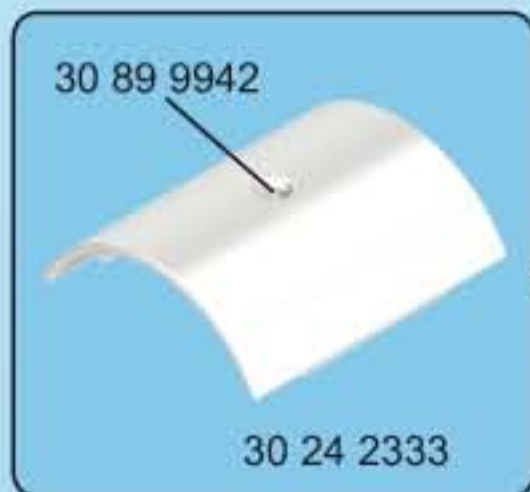

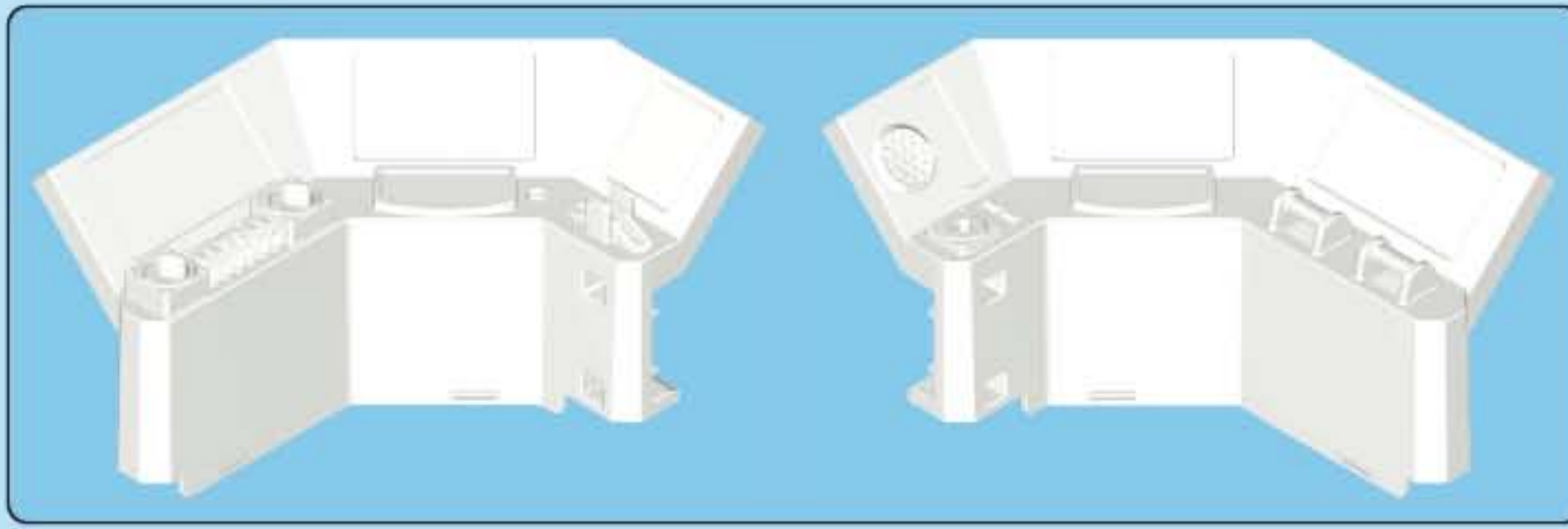

30 51 4832



30 24 2423

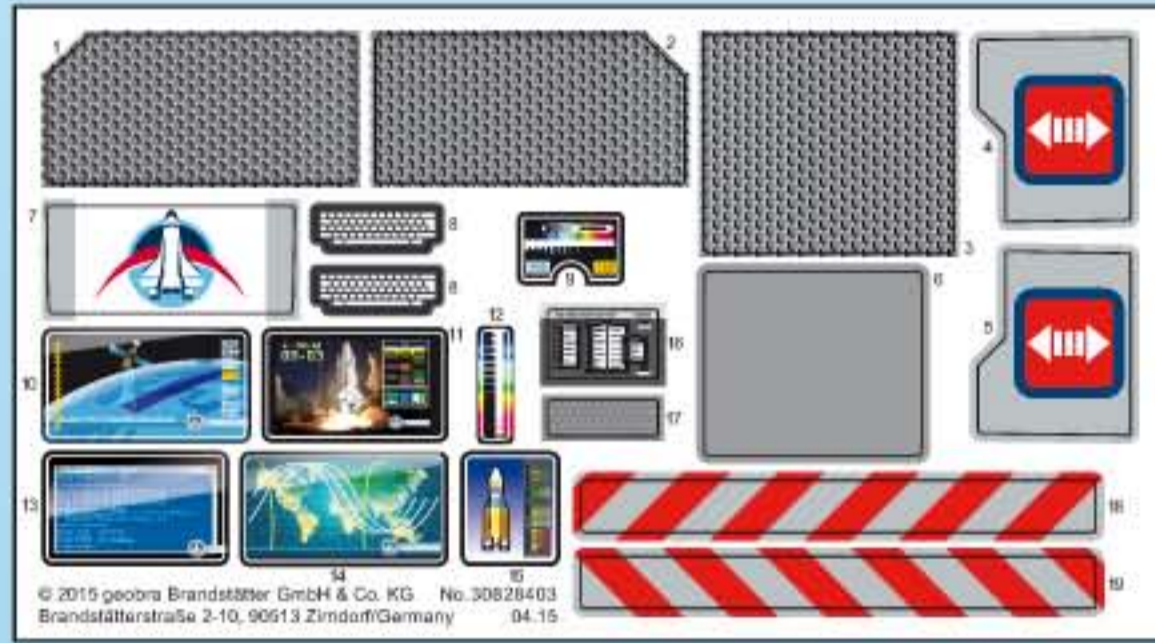

30 82 8403



30 64 2634



30 23 7882



30 24 2213

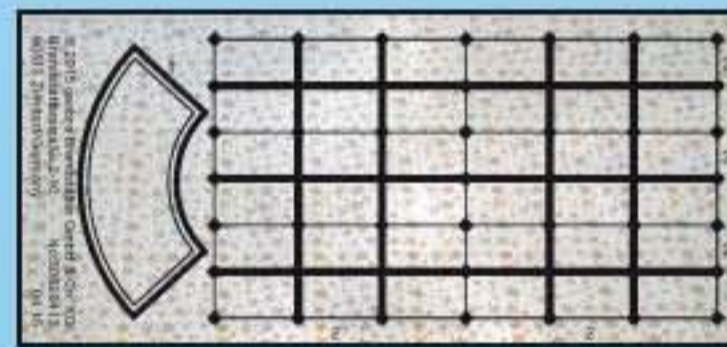

30 82 8413



2x 30 24 2503



30 24 2533



30 21 5170



2x 30 24 2383



30 21 5682



30 21 3740



30 24 2583



30 65 3023



4x 30 24 2083



30 22 3200



30 03 2940



2x 30 24 2513



2x 30 27 2950



30 24 7172



2x 30 24 2493



2x 30 23 5630



2x 30 24 2413



2x 30 24 2473



30 51 4842



2x 30 24 2543



30 21 3890



30 21 3780



30 21 3060



2x 30 09 9920



2x 30 24 2483



2x 30 21 6370



30 09 4020



30 21 9830



30 51 4852



30 23 1672



30 03 2450



30 25 2343



2x 30 02 5200



30 51 0332



30 24 2523



30 22 3662



30 22 5210



30 24 2403



30 24 2393



30 21 4430



2x 30 07 7040



30 27 5500



(D) (A) (CH) (L) (B) Denken Sie an den Schutz der Umwelt !

- Ihr Gerät enthält wertvolle Rohstoffe, die wieder verwertet werden können.
- Geben Sie Ihr Gerät deshalb bitte bei einer Sammelstelle Ihrer Stadt oder Gemeinde ab.

(GB) (M) (IRL) Environment protection first !

- Your appliance contains valuable materials which can be recovered or recycled.
- Leave it at a local civic waste collection point.

(F) (L) (CH) Participons à la protection de l'environnement !

- Votre appareil contient de nombreux matériaux valorisables ou recyclables.
- Confiez celui-ci dans un point de collecte pour que son traitement soit effectué.

(E) ¡¡ Participe en la conservación del medio ambiente !!

- Su electrodoméstico contiene materiales recuperables y/o reciclables.
- Entréguelo al final de su vida útil, en un Centro de Recogida Específico o en uno de nuestros Servicios Oficiales Post Venta donde será tratado de forma adecuada.

(NL) (B) Samen het milieu beschermen !

- Uw product bevat meerdere recycleerbare materialen.
- Breng deze naar een afval-inzamelpunt.

(B) Participons à la protection de l'environnement !

- Votre appareil contient de nombreux matériaux valorisables ou recyclables.
- Confiez celui-ci dans un point de collecte ou à défaut dans un centre service agréé pour que son traitement soit effectué.

(I) (CH) Partecipiamo alla protezione dell'ambiente !

- Il vostro apparecchio è composto da diversi materiali che possono essere riciclati.
- Lasciatelo in un punto di raccolta o presso un Centro Assistenza Autorizzato.

(P) Protecção do ambiente em primeiro lugar!

- O seu produto contém materiais que podem ser recuperados ou reciclados.
- Entregue-o num ponto de recolha para possibilitar o seu tratamento.

(DK) Vi skal alle være med til at beskytte miljøet!

- Apparatet indeholder mange materialer, der kan genvindes eller genbruges.
- Bring det til et specialiseret indsamlingssted for genbrug eller et autoriseret serviceværksted, når det ikke skal bruges mere.

(S) (FIN) Var rädd om miljön!

- Din apparat innehåller olika material som kan återanvändas eller återvinnas.
- Lämn den på en återvinningsstation eller på en auktoriserad serviceverkstad för omhändertagande och behandling.

(FIN) Huolehtikaamme ympäristöstä!

- I Laitteesi on varustettu monilla arvokkailla ja kierrätettävillä materiaaleilla.
- Toimita laitteesi keräyspisteeseen tai sellaisen puuttuessa vaikka valtuutettuun huoltokekkukseen, jotta laitteen osat varmasti kierrätetään.

(H) Első a környezetvédelem!

- Az Ön terméke értékes újrahasznosítható anyagokat tartalmaz.
- Kérjük készülékét ne dobja ki, hanem adja le az erre a célra kijelölt gyűjtőhelyen.

(CZ) Podílejme se na ochraně životního prostředí!

- Váš přístroj obsahuje četné hodnotitelné nebo recyklovatelné materiály.
- Světe jej sběrnému místu nebo, neexistuje-li, smluvnímu servisnímu středisku, kde s ním bude naloženo odpovídajícím způsobem.

(SLO) Sodelujmo pri varovanju okolja!

- Vaš aparat vsebuje številne dele, ki imajo svojo vrednost ali jih je še mogoče uporabiti.
- Oddajte ga na mestu za zbiranje odpadkov ali pa na pooblaščenem servisu, da bo šel v predelavo.

(SK) Podielajme sa na ochrane životného prostredia!

- Váš prístroj obsahuje četné hodnotiteľné alebo recyklovateľné materiály.
- Zverte ho sběrnému miestu alebo, ak neexistuje, zmluvnému servisnému stredisku, kde s ním bude naložené zodpovedajúcim spôsobom.

(PL) Bierzmy czynny udział w ochronie środowiska!

- Twoje urządzenie jest zbudowane z materiałów, które mogą być poddane ponownemu przetworzeniu lub recyklingowi.
- W tym celu należy je dostarczyć do wyznaczonego punktu zbiórki.

(GR) (CY) Ας συμβάλλουμε κι εμείς στην προστασία του περιβάλλοντος!

- Η συσκευή σας περιέχει πολλά αξιοποιήσιμα ή ανακυκλώσιμα υλικά.
- Παραδώστε την παλιά συσκευή σας σε κέντρο διαλογής ή σε ένα εξουσιοδοτημένο κατάστημα σέρβις.

(RO) Țineți cont de protecția mediului !

- Aparatul dvs. conține materii prime valoroase care pot fi revalorificate.
- Din acest motiv vă rugăm să predați aparatul dvs. la un centru de colectare din orașul sau comuna dvs.

(BG) Мислете за околната среда !

- Вашият уред съдържа ценни суровини, които могат да бъдат рециклирани.
- Затова върнете своя електроуред на специално място за събиране на такива отпадъци във Вашия град или община.

(USA)

This device complies with Part 15 of the FCC Rules. Operation is subject to the following two conditions:

- (1) This device may not cause harmful interference, and
- (2) this device must accept any interference received, including interference that may be caused by undesired operation.

(CDN) CAN ICES-3 (B)/NMB-3(B)

Cet équipement est conforme à la Section 15 des règlements de la FCC. Son fonctionnement est soumis aux deux conditions suivantes:

- (1) Cet équipement ne peut causer d'interférence nuisible, et
- (2) cet équipement doit pouvoir fonctionner même s'il capte de l'interférence, incluant celle pouvant provoquer un fonctionnement indésirable.

Serviceadressen finden Sie in allen Playmobil-Prospekten

Addresses of Customer Service Departments are shown in all Playmobil catalogues

L'adresse du service consommateurs est indiquée dans tous les catalogues Playmobil

Troverete gli indirizzi dei centri di assistenza in tutti i cataloghi Playmobil

In alle PLAYMOBIL catalogi vindt u het adres van onze klantendienst.

Las Direcciones de los Departamentos de Servicio al Consumidor se encuentran en todos los catálogos Playmobil

Η διεύθυνση του Γραφείου Εξυπηρέτησης Καταναλωτών PLAYMOBIL βρίσκεται σε όλους τους καταλόγους PLAYMOBIL.

pronounce: plāy-mō-bēil

6195 + 6196

1

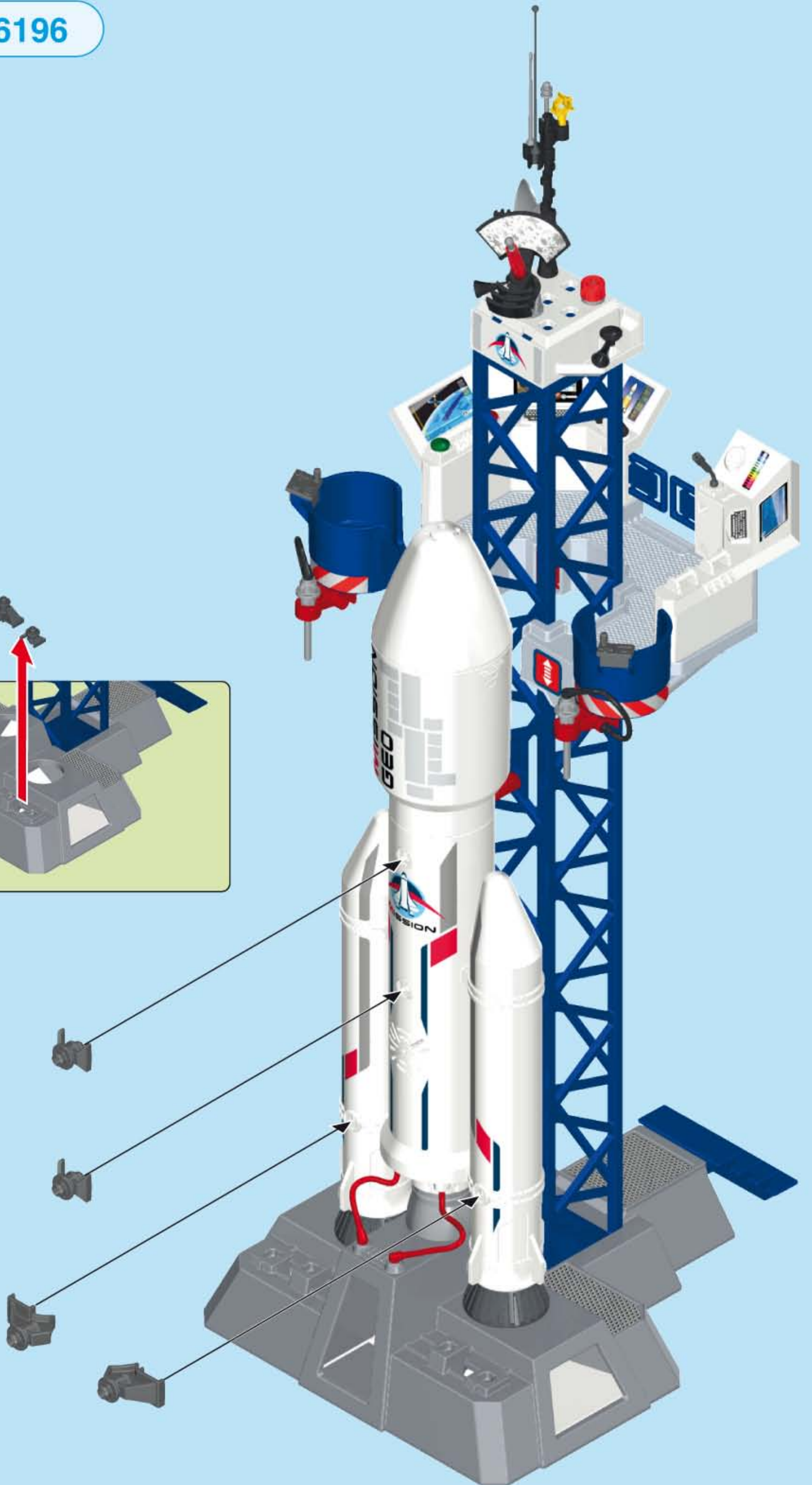
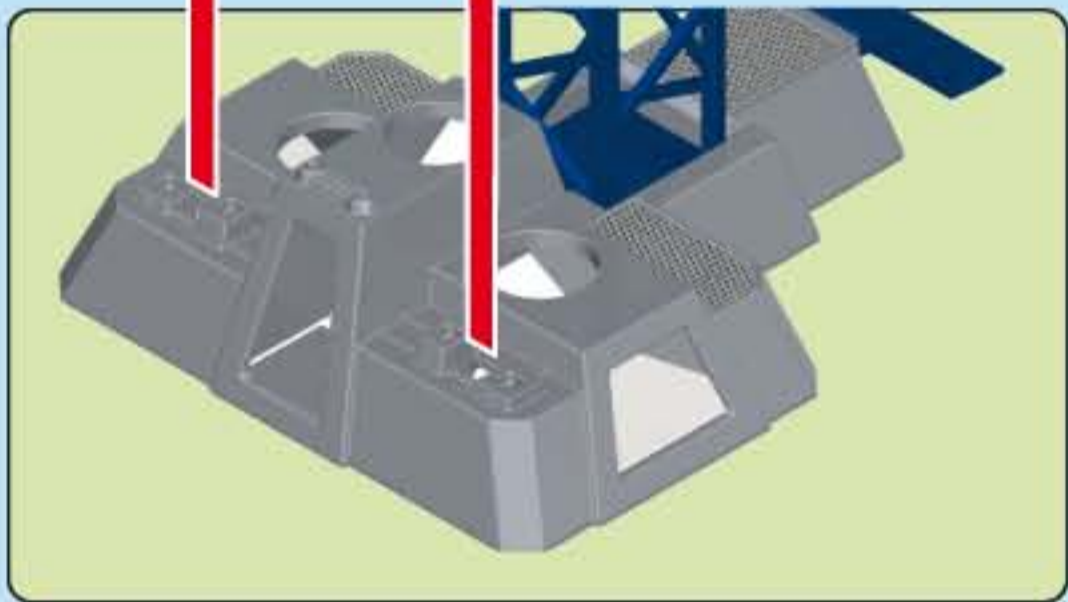

2

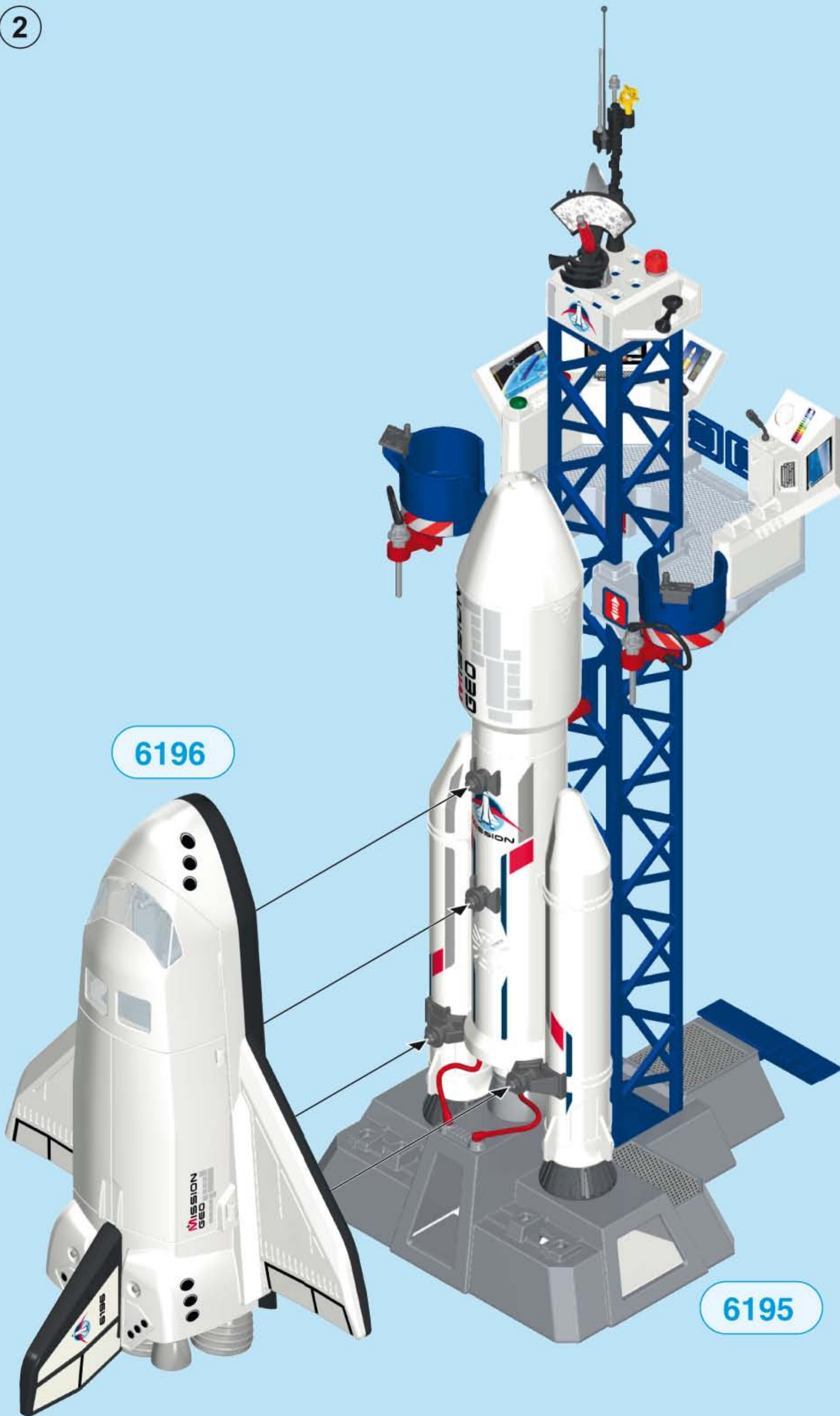

6196

6195



© 2015 geobra Brandstätter Stiftung & Co.KG
Brandstätterstr. 2-10
90513 Zirndorf, Germany.
No. 30 82 1224 07.15

www.playmobil.com